

MICRO-COMPUTER BASED
DIGITAL INDICATING CONTROLLER

JCL-33A

INSTRUCTION MANUAL

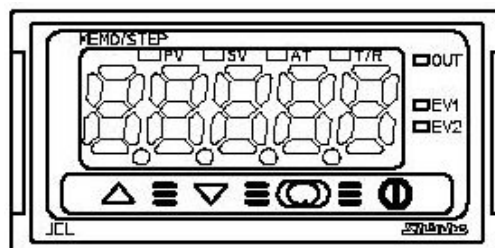

Shinko

Preface

Thank you for purchasing our Micro-computer based Digital Indicating Controller JCL-33A. This manual contains instructions for the mounting, functions, operations and notes when operating the JCL-33A. For model confirmation and unit specifications, please read this manual carefully before starting operation.

To prevent accidents arising from the misuse of this controller, please ensure the operator using it receives this manual.

Notes

- This instrument should be used according to the specifications described in the manual. If it is not used according to the specifications, it may malfunction or cause fire.
- Be sure to follow the warnings, cautions and notices. If it is not, serious injury or accidents may occur.
- The contents of this instruction manual are subject to change without notice.
- Care has been taken to assure that the contents of this instruction manual are correct, but if there are any doubts, mistakes or questions, please inform our sales department.
- This instrument is designed to be installed in a control panel. If it is not, measures must be taken to ensure that the operator cannot touch power terminals or other high voltage sections.
- Any unauthorized transfer or copying of this document, in part or in whole, is prohibited.
- Shinko Technos CO., LTD. is not liable for any damages or secondary damages incurred as a result of using this product, including any indirect damages.

Safety precautions

(Be sure to read these precautions before using our products.)

The safety precautions are classified into categories: "Warning" and "Caution".

Depending on circumstances, procedures indicated by  Caution may be linked to serious results, so be sure to follow the directions for usage.

Warning

Procedures which may lead to dangerous conditions and cause death or serious injury, if not carried out properly.

Caution

Procedures which may lead to dangerous conditions and cause superficial to medium injury or physical damage or may degrade or damage the product, if not carried out properly.

1. Installation precautions



Caution

This instrument is intended to be used under the following environmental conditions (IEC61010-1): Overvoltage category II, Pollution degree 2

Ensure the mounting location corresponds to the following conditions:

- A minimum of dust, and an absence of corrosive gases
- No flammable, explosive gases
- No mechanical vibrations or shocks
- No exposure to direct sunlight, an ambient temperature of 0 to 50°C (32 to 122°F) that does not change rapidly
- An ambient non-condensing humidity of 35 to 85%RH
- No large capacity electromagnetic switches or cables through which large current is flowing
- No water, oil or chemicals or where the vapors of these substances can come into direct contact with the unit

Note: Do not install this instrument near flammable material even though the case of this instrument is made of flame resistant resin.

Avoid setting this instrument directly on flammable material.

2. Wiring precautions



Caution

- Use the solderless terminal with an insulation sleeve that fits in the M3 screw when wiring the JCL-33A Series.
- The terminal block of this instrument is designed to be wired from the left side. The lead wire must be inserted from the left side of the terminal, and fastened with the terminal screw.
- Tighten the terminal screw within the specified torque. If excessive force is applied to the screw when tightening, the terminal screw or case may be damaged.
- Do not apply a commercial power source to the sensor which is connected to the input terminal nor allow the power source to come into contact with the sensor.
- This controller does not have built-in power switch, circuit breaker or fuse. It is necessary to install them near the controller.
(Recommended fuse: Time-lag fuse, rated voltage 250V AC, rated current 2A)
- When using a 24V AC/DC for the power source, do not confuse the polarity when it is DC.

3. Running and maintenance precautions



Warning

- It is recommended that the PID auto-tuning be performed on the trial run.
- Do not touch live terminals. This may cause electric shock or problems in operation.
- Turn the power supplied to the instrument OFF before retightening the terminal and cleaning. Working or touching the terminal with the power switched ON may result in severe injury or death due to Electric Shock.
- Use a soft, dry cloth when cleaning the instrument.
(If paint thinner is used, it might deform or tarnish the unit)
- As the display section is vulnerable, do not strike or scratch it with a hard object.

--- CONTENTS ---

1. Model name	
1.1 Model name -----	5
1.2 How to read the model nameplate -----	5
2. Name and functions of the sections -----	5
3. Mounting to control panel	
3.1 Site selection -----	6
3.2 External dimensions -----	6
3.3 Panel cutout -----	6
3.4 Mounting -----	6
4. Wiring connection -----	7
5. Setup -----	8
6. Operation	
6.1 Main setting mode -----	14
6.2 Sub setting mode -----	16
6.3 Auxiliary function setting mode 1 -----	17
7. Running	
7.1 Start running -----	18
7.2 MV (Control output manipulated variable) indication -----	19
7.3 Control output OFF function -----	19
7.4 Auto-tuning (AT) Perform/Cancel -----	19
8. Operation flowchart -----	20
9. PID auto-tuning -----	22
10. Action explanation	
10.1 OUT action -----	23
10.2 OUT ON/OFF action -----	23
10.3 A1, A2 action -----	24
10.4 Heating/Cooling control action (When option DR is added) -----	24
10.5 Heating/Cooling control action (When setting dead band) (When option DR is added) -----	25
10.6 Heating/Cooling control action (When setting overlap band) (When option DR is added) -----	25
10.7 Timer action -----	25
11. Specifications	
11.1 Standard specifications -----	26
11.2 Optional specifications -----	28
12. Troubleshooting	
12.1 Indication -----	29
12.2 Key operation -----	30
12.3 Control -----	30
13. Character table -----	31

1. Model name

1.1 Model name

JCL- 33 A -□/□ □, □□□		Series name: JCL-33A (W48 x H24 x D98.5mm)	
A1	A	Alarm action can be selected by keypad. *1	
OUT (Control output)	R	Relay contact: 1a	
	S	Non-contact voltage (for SSR drive): 12 ⁺² ₀ V DC	
	A	DC current: 4 to 20mA DC	
Input	M	Multi-range *2	
Supply voltage	1	24V AC/DC *3	
Option	DR	Heating/Cooling control output	Relay contact output
	C5	Serial communication (RS-485)	
	BK	Color: Black	
	TC	Terminal cover	

*1: Alarm actions (9 types and No alarm action), Timer function and Pattern end output can be selected by keypad.

*2: Thermocouple, RTD, DC current and DC voltage can be selected by keypad.

For DC current input, 50Ω shunt resistor must be installed between input terminals.

*3: 100 to 240V AC is standard specification for the supply voltage. However, when ordering 24V AC/DC, enter "1" after the input code.

1.2 How to read the model nameplate

Model nameplates are attached to the case and the inner assembly.

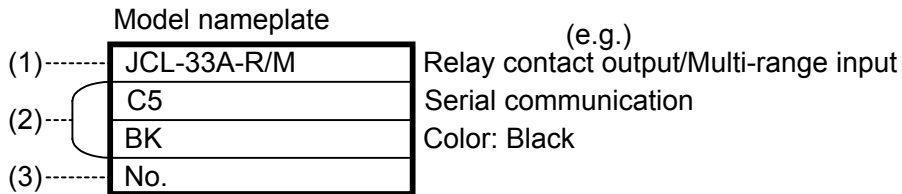

(1): Model name

(2): Option, supply voltage ("1" is entered only for 24V AC/DC)

(3): Instrument No. (Only on the inner assembly)

2. Name and functions of the sections

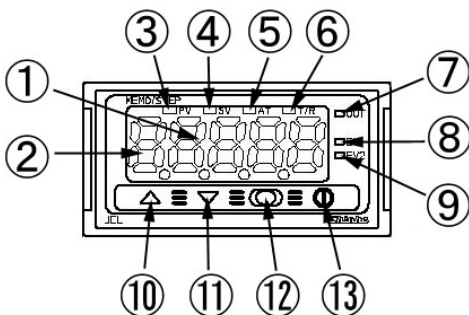

- ① **PV/SV display (red)**: Indicates the input value and setting value. During setting mode, characters and setting value of the setting item are indicated in turn.
- ② **MEMO/STEP display (green)**: Indicates memory number during fixed value control. Indicates step number during program control.
- ③ **PV indicator (red)**: Lights up when the input value (PV) is indicated.
- ④ **SV indicator (green)**: Lights up when main setting value (SV) is indicated.

⑤ **AT indicator (yellow)** : Blinks during AT (auto-tuning).

⑥ **T/R indicator (yellow)**: Blinks during serial communication (Lit while sending data, Unlit while receiving data)

⑦ **OUT indicator (green)**: Lights up when OUT or Heating output is ON. (For DC current output type, it blinks corresponding to the manipulated variable in a 0.25 second cycle)

⑧ **EV1 indicator (red)** : Lights up when Event output 1 or Cooling output is ON.

⑨ **EV2 indicator (red)** : Lights up when Event output 2 is ON.

⑩ **Increase key (△)** : Increases the numeric value.

⑪ **Decrease key (▽)** : Decreases the numeric value.

⑫ **Mode key (○)** : Selects the setting mode or registers the setting value.

(By pressing the Mode key, the setting value or selected value can be registered)

⑬ **OUT/OFF key (Ⓛ)** : The control output OUT/OFF or program control RUN/STOP can be switched.

3. Mounting to control panel

3.1 Site selection

This instrument is intended to be used under the following environmental conditions (IEC61010-1): **Overvoltage category II, Pollution degree 2**

Ensure the mounting location corresponds to the following conditions:

- A minimum of dust, and an absence of corrosive gases
- No flammable, explosive gases
- No mechanical vibrations or shocks
- No exposure to direct sunlight, an ambient temperature of 0 to 50°C (32 to 122°F) that does not change rapidly
- An ambient non-condensing humidity of 35 to 85%RH
- No large capacity electromagnetic switches or cables through which large current is flowing
- No water, oil or chemicals or where the vapors of these substances can come into direct contact with the controller

3.2 External dimensions

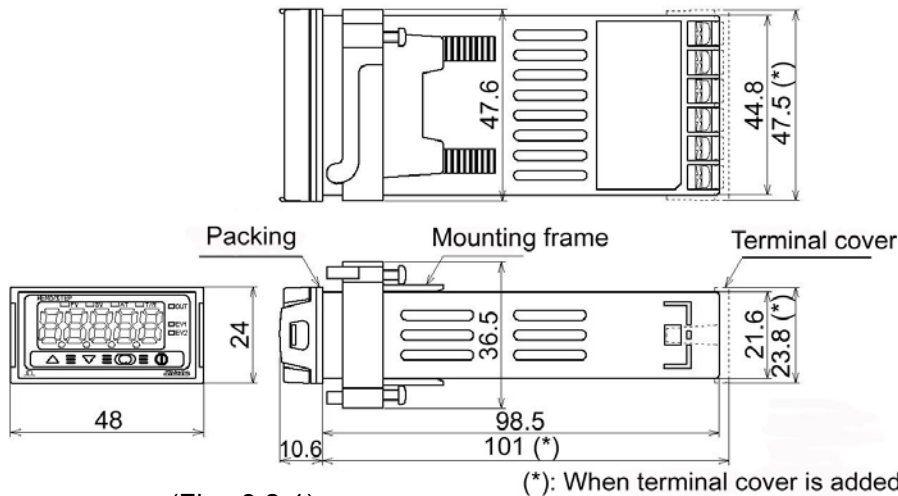

(Fig. 3.2-1)

(*): When terminal cover is added.

3.3 Panel cutout

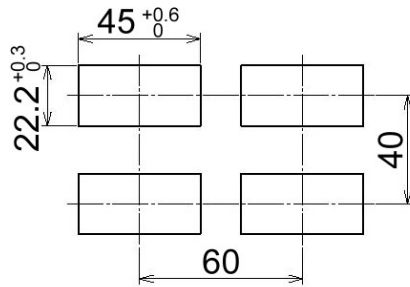

(Fig. 3.3-1)

3.4 Mounting

Mount the controller vertically so that dust and water do not enter, fulfilling the Dust-proof/Drip-proof specification (IP66).

Mountable panel thickness: Within 1 to 10mm

(1) Insert the controller from the front side of the panel. (Fig. 3.4-1)

(2) Insert the mounting frame until 2 tips of the frame touch the panel. (Fig. 3.4-2)

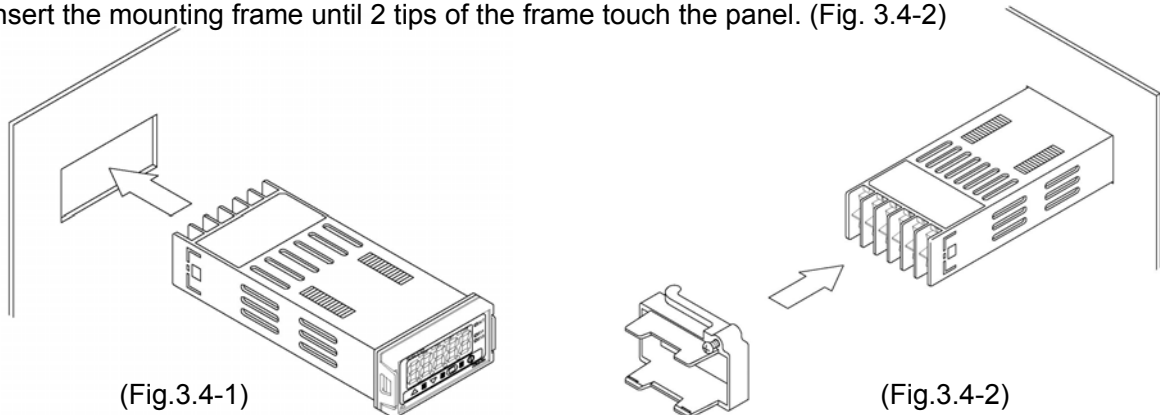

(Fig.3.4-1)

(Fig.3.4-2)

4. Wiring connection



Warning

Turn the power supply to the instrument off before wiring.
Working or touching the terminal with the power switched on may result in severe injury or death due to Electric Shock.

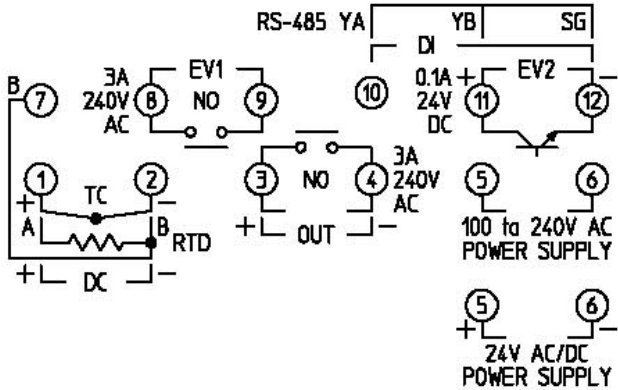

(Fig. 4-1)

- POWER SUPPLY: Power terminals
- EV1 : Event output 1 terminals or Cooling output (when option DR is added) terminals
- EV2 : Event output 2 terminals
- OUT : Control output or Heating output (when option DR is added) terminals
- DI : DI (Digital input) terminals
Three DI functions: SV1/SV2 external selection function, OUT/OFF (RUN/STOP) external selection and Timer function
- RS-485: Serial communication (C5) terminals
- TC : Thermocouple input terminals
- RTD : RTD input terminals
- DC : DC current, DC voltage terminals
For DC current input type, connect 50Ω shunt resistor (sold separately) between input terminals.



Notice

- Use a thermocouple and compensating lead wire corresponding to the sensor input specification of this controller.
- Use the 3-wire RTD which corresponds to the input specification of this controller.
- This controller does not have built-in power switch, circuit breaker or fuse. Therefore, it is necessary to install them in the circuit near the external controller.
(Recommended fuse: Time-lag fuse, rated voltage 250V AC, rated current 2A)
- **When using a 24V AC/DC for the power source, do not confuse the polarity when it is DC.**
- When using a relay contact output type, externally use a relay according to the capacity of the load to protect the built-in relay contact.
- When wiring, keep input wires (thermocouple, RTD, etc.) away from AC sources or load wires to avoid external interference.
- Do not apply a commercial power source to the sensor connected to the input terminal nor allow the power source to come into contact with the sensor.

Lead wire solderless terminal

Use a solderless terminal with an isolation sleeve that fits to the M3 screw as shown below. The torque is approximately 0.6N•m to 1.0N•m.

Solderless terminal	Manufacturer	Model name	Tightening torque
Y type	Nichifu Terminal Industries CO., LTD.	1.25Y-3	0.6N•m Max. 1.0N•m
	Japan Solderless Terminal MFG CO., LTD.	VD1.25-B3A	
Round type	Nichifu Terminal Industries CO., LTD.	1.25-3	
	Japan Solderless Terminal MFG CO., LTD.	V1.25-3	

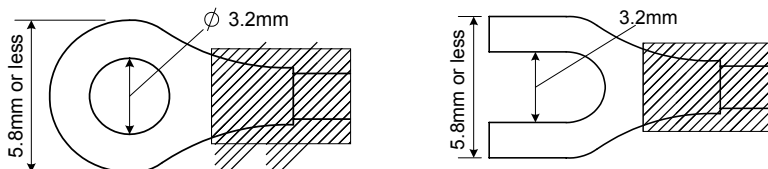

(Fig. 4-2)

5. Setup

Before using this controller, it is necessary to set up the Input type, Alarm action, Control action, etc. according to the users' conditions.

Default value is set as follows.

Input: K –200 to 1370°C, Alarm 1 (A1): No alarm action, Alarm 2 (A2): No alarm action, Reverse (Heating) control action

If the users' specification is the same as the default value of the JCL-33A, it is not necessary to set up the controller. Proceed to Section "6.1 Main setting mode".

■ Turn the power supply to the instrument on.

For approx. 3 seconds after the power is turned on, the MEMO/STEP display is turned off and the PV/SV display indicates sensor input character and temperature unit.

During this time, all outputs and LED indicators are in OFF status.

(Table 5-1)



Sensor input	PV/SV display	
	°C	F
K	K C	K F
J	J C	J F
R	R C	R F
S	S C	S F
B	B C	B F
E	E C	E F
T	T C	T F
N	N C	N F
PL-II	PL2C	PL2F
C (W/Re5-26)	C C	C F
Pt100	Pt C	Pt F
JPt100	JPt C	JPt F
4 to 20mA DC	420A	
0 to 20mA DC	020A	
0 to 1V DC	0 1V	
0 to 5V DC	0 5V	
1 to 5V DC	1 5V	
0 to 10V DC	0 10V	

After that, the following is indicated.



The MEMO/STEP display indicates a memory number.

The PV/SV display indicates an input value (e.g. room temperature).

This is the PV/SV display mode.

■ Basic operation for setup

Setup is conducted in Auxiliary function setup mode 2.

To go to Auxiliary function setup mode 2, press the Δ key for approx. 3 seconds while holding down the ∇ key in the PV/SV display mode.

Set or select the values with Δ and ∇ key.

Register the values with the C key.

■ Display used for explaining setting items



Setting items (Chapter "5 Setup" and setting modes from Section 6.1 to 6.3) are explained as follows.

(e.g.) Input type selection





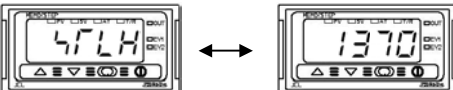



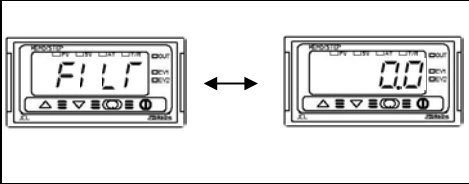
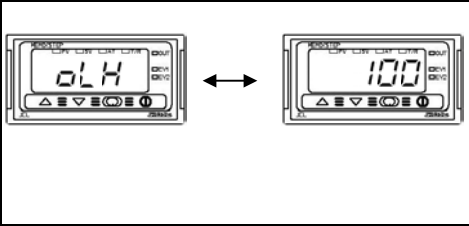
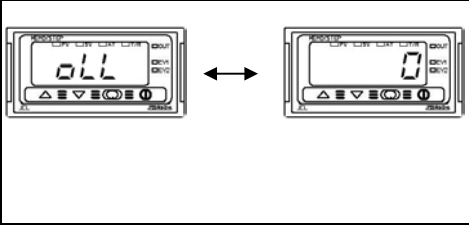
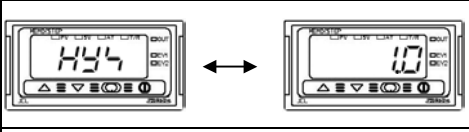
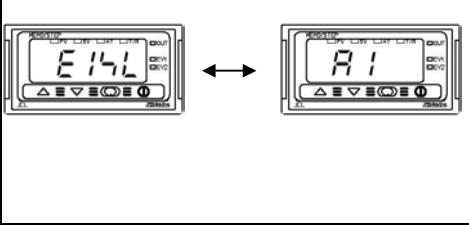
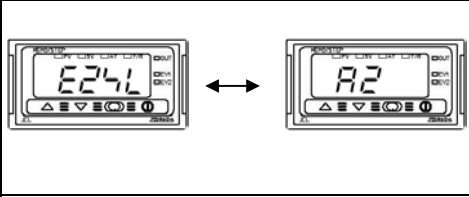
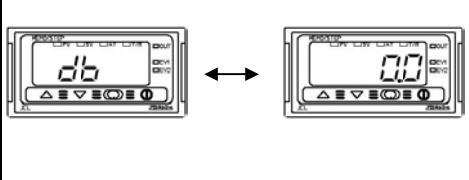
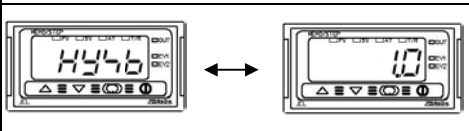
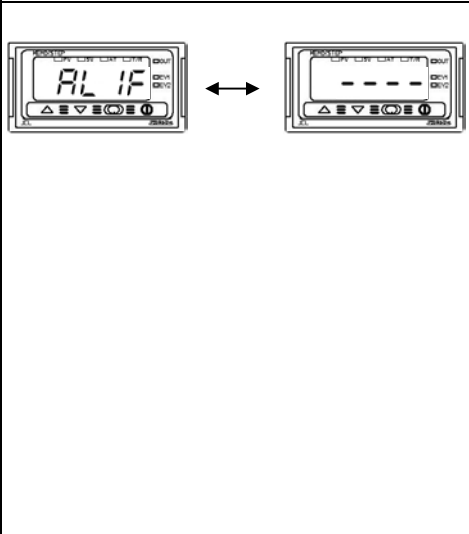

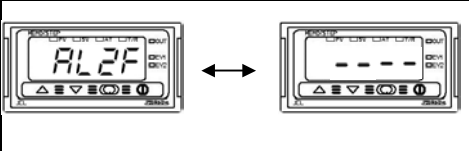
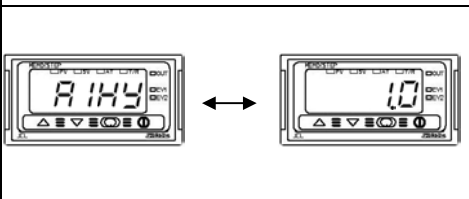
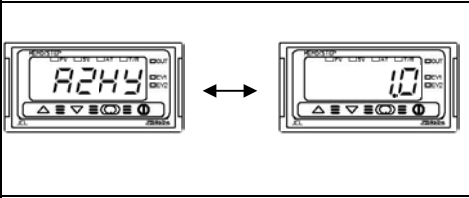
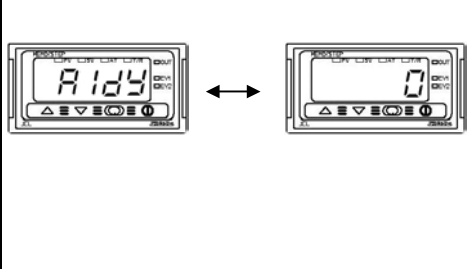
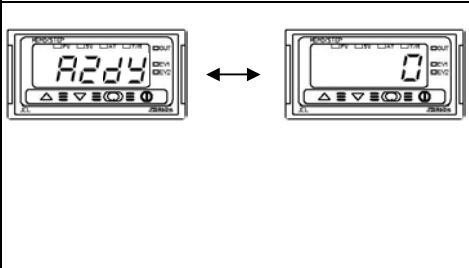
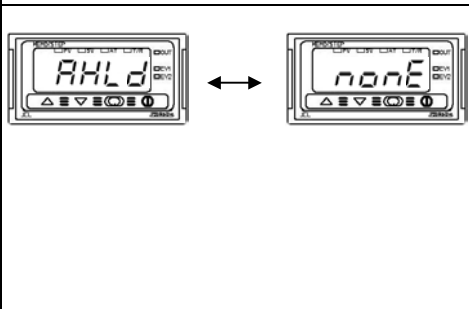
\longleftrightarrow means that input type characters 4En4 and selected value K C (K –200 to 1370°C) are indicated in turn.

Auxiliary function setting mode 2

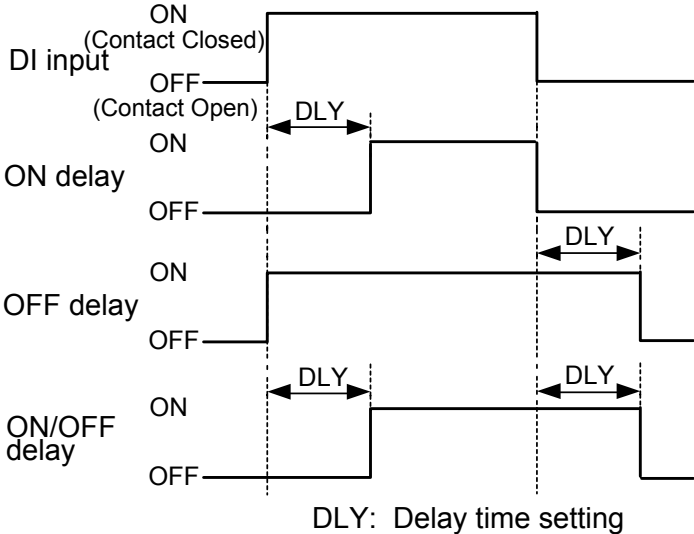
Display	Item, Function, Setting range	Default value																																																																																																												
	Input type selection <ul style="list-style-type: none"> The input type can be selected from thermocouple (10 types), RTD (2 types), DC current (2 types) and DC voltage (4 types). The unit °C/°F can be selected as well. When changing the input from DC voltage to other inputs, remove the sensor connected to this controller first, then change for the input. If the input is changed with the sensor connected, the input circuit may be broken. 	K (-200 to 1370°C)																																																																																																												
	<table border="0"> <tr><td><i>E</i>□□□:</td><td>K</td><td>-200 to 1370 °C</td></tr> <tr><td><i>E</i>□□□:</td><td></td><td>-199.9 to 400.0°C</td></tr> <tr><td><i>J</i>□□□:</td><td>J</td><td>-200 to 1000 °C</td></tr> <tr><td><i>r</i>□□□:</td><td>R</td><td>0 to 1760 °C</td></tr> <tr><td><i>S</i>□□□:</td><td>S</td><td>0 to 1760 °C</td></tr> <tr><td><i>b</i>□□□:</td><td>B</td><td>0 to 1820 °C</td></tr> <tr><td><i>E</i>□□□:</td><td>E</td><td>-200 to 800 °C</td></tr> <tr><td><i>r</i>□□□:</td><td>T</td><td>-199.9 to 400.0°C</td></tr> <tr><td><i>r</i>□□□:</td><td>N</td><td>-200 to 1300 °C</td></tr> <tr><td><i>PL2</i>□:</td><td>PL-II</td><td>0 to 1390 °C</td></tr> <tr><td><i>c</i>□□□:</td><td>C (W/Re5-26)</td><td>0 to 2315 °C</td></tr> <tr><td><i>PT</i>□□:</td><td>Pt100</td><td>-199.9 to 850.0°C</td></tr> <tr><td><i>JPT</i>□:</td><td>JPt100</td><td>-199.9 to 500.0°C</td></tr> <tr><td><i>PT</i>□□:</td><td>Pt100</td><td>-200 to 850 °C</td></tr> <tr><td><i>JPT</i>□:</td><td>JPt100</td><td>-200 to 500 °C</td></tr> <tr><td><i>E</i>□□□:</td><td>K</td><td>-320 to 2500 °F</td></tr> <tr><td><i>E</i>□□□:</td><td></td><td>-199.9 to 750.0°F</td></tr> <tr><td><i>J</i>□□□:</td><td>J</td><td>-320 to 1800 °F</td></tr> <tr><td><i>r</i>□□□:</td><td>R</td><td>0 to 3200 °F</td></tr> <tr><td><i>S</i>□□□:</td><td>S</td><td>0 to 3200 °F</td></tr> <tr><td><i>b</i>□□□:</td><td>B</td><td>0 to 3300 °F</td></tr> <tr><td><i>E</i>□□□:</td><td>E</td><td>-320 to 1500 °F</td></tr> <tr><td><i>r</i>□□□:</td><td>T</td><td>-199.9 to 750.0°F</td></tr> <tr><td><i>r</i>□□□:</td><td>N</td><td>-320 to 2300 °F</td></tr> <tr><td><i>PL2</i>□:</td><td>PL-II</td><td>0 to 2500 °F</td></tr> <tr><td><i>c</i>□□□:</td><td>C (W/Re5-26)</td><td>0 to 4200 °F</td></tr> <tr><td><i>PT</i>□□:</td><td>Pt100</td><td>-199.9 to 999.9°F</td></tr> <tr><td><i>JPT</i>□:</td><td>JPt100</td><td>-199.9 to 900.0°F</td></tr> <tr><td><i>PT</i>□□:</td><td>Pt100</td><td>-300 to 1500 °F</td></tr> <tr><td><i>JPT</i>□:</td><td>JPt100</td><td>-300 to 900 °F</td></tr> <tr><td><i>420</i>□:</td><td>4 to 20mA DC</td><td>-1999 to 9999</td></tr> <tr><td><i>020</i>□:</td><td>0 to 20mA DC</td><td>-1999 to 9999</td></tr> <tr><td><i>01</i>□:</td><td>0 to 1V DC</td><td>-1999 to 9999</td></tr> <tr><td><i>05</i>□:</td><td>0 to 5V DC</td><td>-1999 to 9999</td></tr> <tr><td><i>15</i>□:</td><td>1 to 5V DC</td><td>-1999 to 9999</td></tr> <tr><td><i>010</i>□:</td><td>0 to 10V DC</td><td>-1999 to 9999</td></tr> </table>	<i>E</i> □□□:	K	-200 to 1370 °C	<i>E</i> □□□:		-199.9 to 400.0°C	<i>J</i> □□□:	J	-200 to 1000 °C	<i>r</i> □□□:	R	0 to 1760 °C	<i>S</i> □□□:	S	0 to 1760 °C	<i>b</i> □□□:	B	0 to 1820 °C	<i>E</i> □□□:	E	-200 to 800 °C	<i>r</i> □□□:	T	-199.9 to 400.0°C	<i>r</i> □□□:	N	-200 to 1300 °C	<i>PL2</i> □:	PL-II	0 to 1390 °C	<i>c</i> □□□:	C (W/Re5-26)	0 to 2315 °C	<i>PT</i> □□:	Pt100	-199.9 to 850.0°C	<i>JPT</i> □:	JPt100	-199.9 to 500.0°C	<i>PT</i> □□:	Pt100	-200 to 850 °C	<i>JPT</i> □:	JPt100	-200 to 500 °C	<i>E</i> □□□:	K	-320 to 2500 °F	<i>E</i> □□□:		-199.9 to 750.0°F	<i>J</i> □□□:	J	-320 to 1800 °F	<i>r</i> □□□:	R	0 to 3200 °F	<i>S</i> □□□:	S	0 to 3200 °F	<i>b</i> □□□:	B	0 to 3300 °F	<i>E</i> □□□:	E	-320 to 1500 °F	<i>r</i> □□□:	T	-199.9 to 750.0°F	<i>r</i> □□□:	N	-320 to 2300 °F	<i>PL2</i> □:	PL-II	0 to 2500 °F	<i>c</i> □□□:	C (W/Re5-26)	0 to 4200 °F	<i>PT</i> □□:	Pt100	-199.9 to 999.9°F	<i>JPT</i> □:	JPt100	-199.9 to 900.0°F	<i>PT</i> □□:	Pt100	-300 to 1500 °F	<i>JPT</i> □:	JPt100	-300 to 900 °F	<i>420</i> □:	4 to 20mA DC	-1999 to 9999	<i>020</i> □:	0 to 20mA DC	-1999 to 9999	<i>01</i> □:	0 to 1V DC	-1999 to 9999	<i>05</i> □:	0 to 5V DC	-1999 to 9999	<i>15</i> □:	1 to 5V DC	-1999 to 9999	<i>010</i> □:	0 to 10V DC	-1999 to 9999	
<i>E</i> □□□:	K	-200 to 1370 °C																																																																																																												
<i>E</i> □□□:		-199.9 to 400.0°C																																																																																																												
<i>J</i> □□□:	J	-200 to 1000 °C																																																																																																												
<i>r</i> □□□:	R	0 to 1760 °C																																																																																																												
<i>S</i> □□□:	S	0 to 1760 °C																																																																																																												
<i>b</i> □□□:	B	0 to 1820 °C																																																																																																												
<i>E</i> □□□:	E	-200 to 800 °C																																																																																																												
<i>r</i> □□□:	T	-199.9 to 400.0°C																																																																																																												
<i>r</i> □□□:	N	-200 to 1300 °C																																																																																																												
<i>PL2</i> □:	PL-II	0 to 1390 °C																																																																																																												
<i>c</i> □□□:	C (W/Re5-26)	0 to 2315 °C																																																																																																												
<i>PT</i> □□:	Pt100	-199.9 to 850.0°C																																																																																																												
<i>JPT</i> □:	JPt100	-199.9 to 500.0°C																																																																																																												
<i>PT</i> □□:	Pt100	-200 to 850 °C																																																																																																												
<i>JPT</i> □:	JPt100	-200 to 500 °C																																																																																																												
<i>E</i> □□□:	K	-320 to 2500 °F																																																																																																												
<i>E</i> □□□:		-199.9 to 750.0°F																																																																																																												
<i>J</i> □□□:	J	-320 to 1800 °F																																																																																																												
<i>r</i> □□□:	R	0 to 3200 °F																																																																																																												
<i>S</i> □□□:	S	0 to 3200 °F																																																																																																												
<i>b</i> □□□:	B	0 to 3300 °F																																																																																																												
<i>E</i> □□□:	E	-320 to 1500 °F																																																																																																												
<i>r</i> □□□:	T	-199.9 to 750.0°F																																																																																																												
<i>r</i> □□□:	N	-320 to 2300 °F																																																																																																												
<i>PL2</i> □:	PL-II	0 to 2500 °F																																																																																																												
<i>c</i> □□□:	C (W/Re5-26)	0 to 4200 °F																																																																																																												
<i>PT</i> □□:	Pt100	-199.9 to 999.9°F																																																																																																												
<i>JPT</i> □:	JPt100	-199.9 to 900.0°F																																																																																																												
<i>PT</i> □□:	Pt100	-300 to 1500 °F																																																																																																												
<i>JPT</i> □:	JPt100	-300 to 900 °F																																																																																																												
<i>420</i> □:	4 to 20mA DC	-1999 to 9999																																																																																																												
<i>020</i> □:	0 to 20mA DC	-1999 to 9999																																																																																																												
<i>01</i> □:	0 to 1V DC	-1999 to 9999																																																																																																												
<i>05</i> □:	0 to 5V DC	-1999 to 9999																																																																																																												
<i>15</i> □:	1 to 5V DC	-1999 to 9999																																																																																																												
<i>010</i> □:	0 to 10V DC	-1999 to 9999																																																																																																												
	Scaling high limit setting <ul style="list-style-type: none"> Sets scaling high limit value. Setting range: Scaling low limit value to input range high limit value 	1370°C																																																																																																												
	Scaling low limit setting <ul style="list-style-type: none"> Sets scaling low limit value. Setting range: Input range low limit value to scaling high limit value 	-200°C																																																																																																												
	Decimal point place selection <ul style="list-style-type: none"> Selects decimal point place. Available only for DC input □□□□: No decimal point □□□: 1 digit after decimal point □□□□: 2 digits after decimal point □□□□□: 3 digits after decimal point 	No decimal point																																																																																																												

	<p>PV filter time constant setting</p> <ul style="list-style-type: none"> • Sets PV filter time constant. • Input fluctuation due to the noise can be reduced. • If the value is set too large, it affects control result due to the delay of response. • Setting range: 0.0 to 10.0 seconds 	<p>0.0 seconds</p>
	<p>OUT high limit setting</p> <ul style="list-style-type: none"> • Sets OUT high limit value. • Not available when OUT is ON/OFF action • If option DR is added, OUT terminals are used for Heating output terminals. • Setting range: OUT low limit value to 105% (Setting greater than 100% is effective to DC current output type) 	<p>100%</p>
	<p>OUT low limit setting</p> <ul style="list-style-type: none"> • Sets OUT low limit value. • Not available when OUT is ON/OFF action • If option DR is added, OUT terminals are used for Heating output terminals. • Setting range: -5% to OUT high limit value (Setting less than 0% is effective to DC current output type) 	<p>0%</p>
	<p>OUT ON/OFF action hysteresis setting</p> <ul style="list-style-type: none"> • Sets ON/OFF action hysteresis for OUT. • Available only when OUT is ON/OFF action • Setting range: 0.1 to 100.0°C (°F), or 1 to 1000 	<p>1.0°C</p>
	<p>EV1 output selection</p> <ul style="list-style-type: none"> • Selects a function for EV1 output terminals. • Not available if option DR is added, since EV1 terminals are used for cooling output terminals. • A <input type="checkbox"/>: A1 output • R2 <input type="checkbox"/>: A2 output • or <input type="checkbox"/>: Common to A1 and A2 output 	<p>A1 output</p>
	<p>EV2 output selection</p> <ul style="list-style-type: none"> • Selects a function for EV2 output terminals. • Not available if option C5 is added • A <input type="checkbox"/>: A1 output • R2 <input type="checkbox"/>: A2 output • or <input type="checkbox"/>: Common to A1 and A2 output 	<p>A2 output</p>
	<p>Overlap band/Dead band setting</p> <ul style="list-style-type: none"> • Sets the overlap band or dead band for heating side (OUT) and cooling side. • + setting value: Dead band, - setting value: Overlap band • Available only when the option DR is added • Setting range: -100.0 to 100.0°C (°F), or 1 to 1000 	<p>0.0°C</p>
	<p>Cooling ON/OFF action hysteresis setting</p> <ul style="list-style-type: none"> • Sets ON/OFF action hysteresis for cooling side. • Available only when the option DR is added • Setting range: 0.1 to 100.0°C (°F), or 1 to 1000 	<p>1.0°C</p>
	<p>A1 action selection</p> <ul style="list-style-type: none"> • Selects an action for A1. • ----: No alarm action • H <input type="checkbox"/>: High limit alarm • L <input type="checkbox"/>: Low limit alarm • HL <input type="checkbox"/>: High/Low limits alarm • o l d <input type="checkbox"/>: High/Low limit range alarm • R4 <input type="checkbox"/>: Process high alarm • r R4 <input type="checkbox"/>: Process low alarm • H <input type="checkbox"/>: High limit alarm with standby • L <input type="checkbox"/>: Low limit alarm with standby • HL <input type="checkbox"/>: High/Low limits alarm with standby • T <input type="checkbox"/>: Timer function • PEnd: Pattern end output • If Timer function is selected, Timer function works only when Delay action type, Delay time and DI (digital input) function are set or selected. 	<p>No alarm action</p>

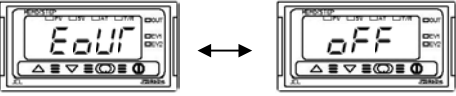
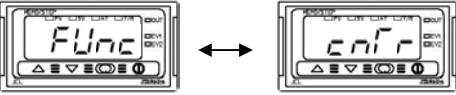

	<p>A2 action selection</p> <ul style="list-style-type: none"> • Selects an action for A2. • Action selection and default value are the same as those of A1 action selection. 	<p>No alarm action</p>
	<p>A1 hysteresis setting</p> <ul style="list-style-type: none"> • Sets hysteresis for A1. • Not available if No alarm action, Timer function or Pattern end output is selected during A1 action selection • Setting range: 0.1 to 100.0°C(°F), or 1 to 1000 	<p>1.0°C</p>
	<p>A2 hysteresis setting</p> <ul style="list-style-type: none"> • Sets hysteresis for A2. • Not available if No alarm action, Timer function or Pattern end output is selected during A2 action selection • Setting range: 0.1 to 100.0°C(°F), or 1 to 1000 	<p>1.0°C</p>
	<p>A1 action delayed timer setting</p> <ul style="list-style-type: none"> • Sets action delayed timer for A1. When setting time has passed after the input enters the alarm output range, the alarm is activated. • Not available if No alarm action, Timer function or Pattern end output is selected during A1 action selection • Setting range: 0 to 9999 seconds 	<p>0 seconds</p>
	<p>A2 action delayed timer setting</p> <ul style="list-style-type: none"> • Sets action delayed timer for A2. When setting time has passed after the input enters the alarm output range, the alarm is activated. • Not available if No alarm action, Timer function or Pattern end output is selected during A2 action selection • Setting range: 0 to 9999 seconds 	<p>0 seconds</p>
	<p>Alarm HOLD function selection</p> <ul style="list-style-type: none"> • Selects whether alarm HOLD function for A1 or A2 is [Used] or [Not used]. • This setting item is common to A1 and A2. Not available if No alarm action, Timer function or Pattern end output is selected during A1 and A2 action selection. • <i>none</i>: Alarm HOLD [Not used] • <i>Hold</i>: Alarm HOLD [Used] 	<p>Alarm HOLD [Not used]</p>

 <p>The diagram shows two thermostat screens. The left screen displays 'dLYF' and the right screen displays 'on'. A double-headed arrow indicates the transition between the two screens.</p>	<p>Delay action type selection ON delay</p> <ul style="list-style-type: none"> • Selects a delay action type for Timer function. • Available only when Timer function is selected during A1 and A2 action selection. • <i>on</i>: ON delay • <i>oFF</i>: OFF delay • <i>on oF</i>: ON/OFF delay  <p>The diagram shows three scenarios for delay actions. In the first, a DI input (Contact Closed) transitions from ON to OFF, and the output (ON delay) transitions from OFF to ON after a delay (DLY). In the second, a DI input (Contact Open) transitions from OFF to ON, and the output (OFF delay) transitions from ON to OFF after a delay (DLY). In the third, a DI input transitions from ON to OFF, and the output (ON/OFF delay) transitions from ON to OFF after a delay (DLY).</p> <p>DLY: Delay time setting (Fig. 5.6-1)</p>
 <p>The diagram shows two thermostat screens. The left screen displays 'dLYF' and the right screen displays '0'. A double-headed arrow indicates the transition between the two screens.</p>	<p>Delay time setting 0 seconds</p> <ul style="list-style-type: none"> • Sets delay time for the Timer function. • Available only when Timer function is selected during A1, A2 action selection. • Setting range: 0 to 9999 seconds
 <p>The diagram shows two thermostat screens. The left screen displays 'conf' and the right screen displays 'HEAT'. A double-headed arrow indicates the transition between the two screens.</p>	<p>Direct/Reverse action selection Reverse (Heating)</p> <ul style="list-style-type: none"> • Selects Reverse (Heating) or Direct (Cooling) control action. • <i>HEAT</i>: Reverse (Heating) action • <i>cool</i>: Direct (Cooling) action
 <p>The diagram shows two thermostat screens. The left screen displays 'AT_b' and the right screen displays '20'. A double-headed arrow indicates the transition between the two screens.</p>	<p>AT bias setting 20°C</p> <ul style="list-style-type: none"> • Sets bias value when performing auto-tuning. • Sets the bias value by which AT point is automatically decided by the deviation between PV and SV. • Not available for DC input • Setting range: 0 to 50°C (0 to 100°F) or 0.0 to 50.0°C (0.0 to 100.0°F)
 <p>The diagram shows two thermostat screens. The left screen displays 'SV_b' and the right screen displays '0'. A double-headed arrow indicates the transition between the two screens.</p>	<p>SVTC bias setting 0</p> <ul style="list-style-type: none"> • Control desired value (SV) adds SVTC bias value to the value received by the SVTC command. • Available only when option C5 is added • Setting range: ±20% of the scaling span
 <p>The diagram shows two thermostat screens. The left screen displays 'Proc' and the right screen displays 'oFF'. A double-headed arrow indicates the transition between the two screens.</p>	<p>OUT/OFF key function selection Control output OUT/OFF function</p> <ul style="list-style-type: none"> • Selects whether OUT/OFF key is used for control output OUT/OFF function (Fixed value control) or for program control RUN/STOP function. • <i>oFF</i>: Control output OUT/OFF function (Fixed value control) • <i>Proc</i>: Program control RUN/STOP function
 <p>The diagram shows two thermostat screens. The left screen displays 'n_4' and the right screen displays 'n/n'. A double-headed arrow indicates the transition between the two screens.</p>	<p>Step time unit selection Hour:Minute</p> <ul style="list-style-type: none"> • Selects Step time unit for the program control function. • Not available when control output OUT/OFF function (Fixed value control) is selected during [OUT/OFF key function selection]. • <i>n/n</i>: Hour:Minute • <i>4Ec</i>: Minute:Second

	<p>DI (Digital input) function selection</p> <ul style="list-style-type: none"> • Selects DI function whether it is used as SV1/SV2 external selection function, OUT/OFF (RUN/STOP) external selection function or a timer function. <p>If SV1/SV2 external selection function is selected; SV1 or SV2 can be switched by external contact. However, this function is not available if Program control function is selected during OUT/OFF key function selection. Between DI terminals Open: SV1 Between DI terminals Closed: SV2</p> <p>If OUT/OFF(RUN/STOP) external selection function is selected; Control output OUT/OFF (Fixed value control) or Program control RUN/STOP can be switched.</p> <p>Fixed value control Between DI terminals Open: OUT (Control allowed) Between DI terminals Closed: OFF (Control prohibited, control output OFF)</p> <p>Program control Program control RUN/STOP can be switched by external contact pulse input (ON time, approx. 30ms). If pulse input enters during program control standby, program control starts. If pulse input enters during program control run, program control stops and the controller reverts to the program control standby mode. If pulse input enters while pattern end output is turned on after program control ended, pattern end output is turned off.</p> <p>If Timer function is selected; Timer counting starts by the external contact, and after the set delay time has passed, the selected event output is turned on.</p> <ul style="list-style-type: none"> • Not available if option C5 is applied. • $4n$: SV1/SV2 external selection function • ouf: OUT/OFF(RUN/STOP) external selection function • tr: Timer function 	<p>SV1/SV2 external selection function</p>
	<p>Output status selection when input burnout</p> <ul style="list-style-type: none"> • Selects whether to turn OUT (Heating side) ON or OFF when DC input is in overscale or underscale. • Available only for DC current output type with DC input • OFF: Output OFF • on: Output ON 	<p>Output OFF</p>
	<p>Controller/Converter function selection</p> <ul style="list-style-type: none"> • Selects whether to use the JCL-33A as a controller or a converter. • If the JCL-33A is switched from a converter to a controller, control parameters which were automatically set when converter function was selected are maintained as they were. Therefore correct the values when using the JCL-33A as a controller. • Available only for DC current output type • $cntr$: Controller • $cnbf$: Converter 	<p>Controller</p>

6. Operation

6.1 Main setting mode

To go to the main setting mode, press the  key in the PV/SV display mode. Set each setting item with the Δ or ∇ key, and register the value with the  key. In the main setting mode, setting items are different depending on the instrument status.

- Fixed value control

Setting items SV1 and SV2 will be indicated.

- Program control



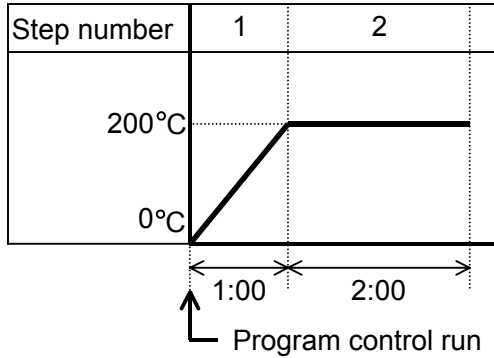











Step SV and step time for 1 to 9 steps will be indicated.

















This program pattern shows that the temperature rises to 200°C for 1 hour and stays at 200°C for 2 hours.



In this case, Step 1 step SV is 200°C and Step 1 step time is 1 hour.

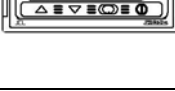
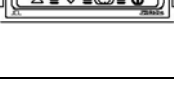
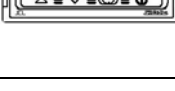

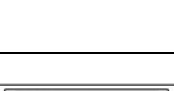
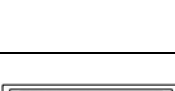
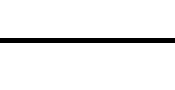
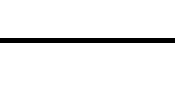







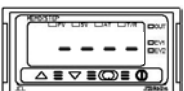









(Fig.6.1-1)

Display	Item, Function, Setting range	Default value
 ↔ 	SV1 (step 1 step SV) setting • Sets SV1 or step 1 step SV. • Scaling low limit value to Scaling high limit value	0°C
 ↔ 	Step 1 step time setting • Sets step 1 step time. • Available only when program control function is selected during OUT/OFF key function selection • Setting range: 00:00 to 99:59	00:00
 ↔ 	SV2 (step 2 step SV) setting • Sets SV2 or step 2 step SV. • Available when SV1/SV2 external selection function is selected during DI (digital input) function selection or when program control function is selected during OUT/OFF key function selection. • Scaling low limit value to Scaling high limit value	0°C
 ↔ 	Step 2 step time setting • Sets step 2 step time. • Available only when program control function is selected during OUT/OFF key function selection • Setting range: 00:00 to 99:59	00:00
 ↔ 	Step 3 step SV setting • Sets step 3 step SV. • Available only when program control function is selected during OUT/OFF key function selection • Scaling low limit value to Scaling high limit value	0°C
 ↔ 	Step 3 step time setting • Sets step 3 step time. • Available only when program control function is selected during OUT/OFF key function selection • Setting range: 00:00 to 99:59	00:00
 ↔ 	Step 4 step SV setting • Sets step 4 step SV. • Available only when program control function is selected during OUT/OFF key function selection • Scaling low limit value to Scaling high limit value	0°C

 	<p>Step 4 step time setting</p> <ul style="list-style-type: none"> • Sets step 4 step time. • Available only when program control function is selected during OUT/OFF key function selection • Setting range: 00:00 to 99:59 	00:00
 	<p>Step 5 step SV setting</p> <ul style="list-style-type: none"> • Sets step 5 step SV. • Available only when program control function is selected during OUT/OFF key function selection • Scaling low limit value to Scaling high limit value 	0°C
 	<p>Step 5 step time setting</p> <ul style="list-style-type: none"> • Sets step 5 step time. • Available only when program control function is selected during OUT/OFF key function selection • Setting range: 00:00 to 99:59 	00:00
 	<p>Step 6 step SV setting</p> <ul style="list-style-type: none"> • Sets step 6 step SV. • Available only when program control function is selected during OUT/OFF key function selection • Scaling low limit value to Scaling high limit value 	0°C
 	<p>Step 6 step time setting</p> <ul style="list-style-type: none"> • Sets step 6 step time. • Available only when program control function is selected during OUT/OFF key function selection • Setting range: 00:00 to 99:59 	00:00
 	<p>Step 7 step SV setting</p> <ul style="list-style-type: none"> • Sets step 7 step SV. • Available only when program control function is selected during OUT/OFF key function selection • Scaling low limit value to Scaling high limit value 	0°C
 	<p>Step 7 step time setting</p> <ul style="list-style-type: none"> • Sets step 7 step time. • Available only when program control function is selected during OUT/OFF key function selection • Setting range: 00:00 to 99:59 	00:00
 	<p>Step 8 step SV setting</p> <ul style="list-style-type: none"> • Sets step 8 step SV. • Available only when program control function is selected during OUT/OFF key function selection • Scaling low limit value to Scaling high limit value 	0°C
 	<p>Step 8 step time setting</p> <ul style="list-style-type: none"> • Sets step 8 step time. • Available only when program control function is selected during OUT/OFF key function selection • Setting range: 00:00 to 99:59 	00:00
 	<p>Step 9 step SV setting</p> <ul style="list-style-type: none"> • Sets step 9 step SV. • Available only when program control function is selected during OUT/OFF key function selection • Scaling low limit value to Scaling high limit value 	0°C
 	<p>Step 9 step time setting</p> <ul style="list-style-type: none"> • Sets step 9 step time. • Available only when program control function is selected during OUT/OFF key function selection • Setting range: 00:00 to 99:59 	00:00

6.2 Sub setting mode

To go to the Sub setting mode, press the  key while pressing Δ key in the PV/SV display mode. Set each setting item with the Δ or ∇ key, and register the value with the .

Display	Item, Function, Setting range	Default value
 ↔ 	AT (Auto-tuning) selection <ul style="list-style-type: none"> • Selects auto-tuning Perform/Cancel. Not available for program control standby status and for control actions other than PID action. • ---- : AT (Auto-tuning) Cancel <i>At</i> : AT (Auto-tuning) Perform 	AT Cancel
 ↔ 	OUT (Heating side) proportional band setting <ul style="list-style-type: none"> • Sets the proportional band for OUT (Heating side). • ON/OFF action when set to 0.0. • Setting range: 0.0 to 110.0% 	2.5%
 ↔ 	Cooling proportional band setting <ul style="list-style-type: none"> • Sets the proportional band for cooling side. • ON/OFF action when set to 0.0. • Not available if option DR is not added or if OUT (Heating side) is ON/OFF action • Setting range: 0.0 to 10.0 times OUT (Heating side) proportional band 	1.0 times
 ↔ 	Integral time setting <ul style="list-style-type: none"> • Sets the integral time. • Setting the value to 0 disables the function. (PD action) • Not available if OUT (Heating side) is ON/OFF action • Setting range: 0 to 1000 seconds 	200 seconds
 ↔ 	Derivative time setting <ul style="list-style-type: none"> • Sets the derivative time. • Setting the value to 0 disables the function. (PI action) • Not available if OUT (Heating side) is ON/OFF action • Setting range: 0 to 300 seconds 	50 seconds
 ↔ 	ARW setting <ul style="list-style-type: none"> • Sets the ARW (anti-reset windup). • Available only for PID action. • Setting range: 0 to 100% 	50%
 ↔ 	OUT (Heating side) proportional cycle setting <ul style="list-style-type: none"> • Sets OUT(Heating side) proportional cycle. • Sets the proportional cycle. • Not available for DC current output type or when OUT (Heating side) is ON/OFF action. • Setting range: 1 to 120 seconds 	Relay contact: 30s Non-contact voltage: 3s
 ↔ 	Cooling proportional cycle setting <ul style="list-style-type: none"> • Sets cooling proportional cycle. • Not available when option DR is not added or when cooling output is ON/OFF action. • Setting range: 1 to 120 seconds 	30 seconds
 ↔ 	Manual reset setting <ul style="list-style-type: none"> • Sets reset value manually. • Available only for P or PD action. • \pmProportional band converted value (For DC input, the placement of the decimal point follows the selection.) 	0.0°C
 ↔ 	A1 setting <ul style="list-style-type: none"> • Sets A1 action point. • Not available if No alarm action, Timer function or Pattern end output is selected during A1 action selection • Setting range: See (Table 6.2-1). 	0°C
 ↔ 	A2 setting <ul style="list-style-type: none"> • Sets A2 action point. • Not available if No alarm action, Timer function or Pattern end output is selected during A2 action selection • Setting range: See (Table 6.2-1). 	0°C



(Table 6.2-1)

Alarm action type	Setting range
High limit alarm	-(Scaling span) to Scaling span
Low limit alarm	-(Scaling span) to Scaling span
High/Low limits alarm	0 to Scaling span
High/Low limit range alarm	0 to Scaling span
Process high alarm	Scaling low limit to Scaling high limit value
Process low alarm	Scaling low limit to Scaling high limit value
High limit alarm with standby	-(Scaling span) to Scaling span
Low limit alarm with standby	-(Scaling span) to Scaling span
High/Low limits alarm w/standby	0 to Scaling span





For the inputs with a decimal point, the negative low limit value is -199.9, and the positive high limit value is 999.9.

All alarm actions except for the Process alarm are \pm deviation setting to the main setting.

6.3 Auxiliary function setting mode 1

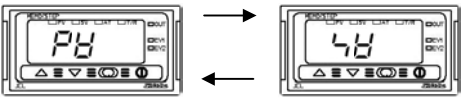
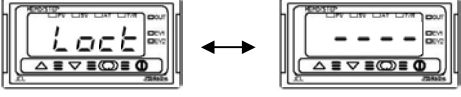
To go to Auxiliary function setting mode 1, press the  key for approx. 3 seconds while holding down  key in the PV/SV display mode.

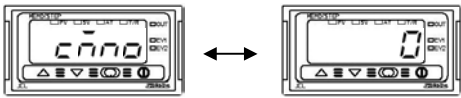
Set each setting item with the  or  key, and register the value with the  key.

Display	Item, Function, Setting range	Default value
	PV/SV indication selection <ul style="list-style-type: none"> PV indication (<i>PB</i>) or SV indication (<i>SB</i>) can be selected. During input burnout, the PV/SV display blinks "----" or "----" even if SV is indicated on the display. 	PV indication
	Setting value lock selection <ul style="list-style-type: none"> Locks the setting values to prevent setting errors. The setting item to be locked depends on the designation. When Lock 1 or Lock 2 is selected, PID Auto-tuning cannot be carried out. Because there is limited non-volatile memory, be sure to select Lock 3 when the setting value is changed frequently via communication function. ---- (Unlock): All setting values can be changed. <i>Loc 1</i> (Lock 1): None of the setting values can be changed. <i>Loc 2</i> (Lock 2): SV1 and SV2 can be changed during fixed value control. Step SV and step time can be changed during program control. Other setting items cannot be changed. <i>Loc 3</i> (Lock 3): All setting values can be changed. However, changed values revert to their former values after the power is turned off because they are not saved in the non-volatile memory. <p>Do not change any setting item in Auxiliary function setting mode 2. If any item in Auxiliary function setting mode 2 is changed, it will affect other setting items such as the SV and Alarm setting.</p>	Unlock
	Sensor correction setting <ul style="list-style-type: none"> Sets the correction value for the sensor. PV=Current process temperature + Sensor correction value Setting range: -100.0 to 100.0°C (°F), or -1000 to 1000 	0.0°C
	Communication protocol selection <ul style="list-style-type: none"> Selects the communication protocol. Available only when the option C5 is applied. <i>nonL</i>: Shinko protocol, <i>nodA</i>: Modbus ASCII mode, <i>nodR</i>: Modbus RTU mode 	Shinko protocol
	Instrument number setting <ul style="list-style-type: none"> Sets the instrument number individually to each instrument when communicating by connecting plural instruments in serial communication. Available only when option C5 is added. Setting range: 0 to 95 	0
	Communication speed selection <ul style="list-style-type: none"> Selects a communication speed to be equal to the speed of the host computer. Available only when option [C5] is added. <i>24</i>: 2400bps <i>96</i>: 9600bps <i>48</i>: 4800bps <i>192</i>: 19200bps 	9600bps

7. Running

7.1 Start running.

After the controller has been mounted to the control panel and wiring is completed, it can be started in the following manner.

(1) Turn the power supply to the JCL-33A ON.

For approx. 3s after the power is switched ON, the sensor input character and the temperature unit are indicated on the PV/SV display. See (Table 5-1) on page 8.

During this time, all outputs and LED indicators are in OFF status.

After that, control starts indicating the following depending on the controller status.

- **Fixed value control status**

Control starts indicating memory number on the MEMO/STEP display and input value or main setting value (SV) on the PV/SV display. (If PV indication is selected during PV/SV indication selection, input value is indicated. If SV indication is selected during PV/SV indication selection, main setting value is indicated.)

- **Program control standby status**

The MEMO/STEP display is turned off, and the PV/SV display indicates input value or "4.63". (If PV indication is selected during PV/SV indication selection, input value is indicated. If SV indication is selected during PV/SV indication selection, main setting value is indicated.)

- **Program control run status**

The MEMO/STEP display indicates step number, and the PV/SV display indicates input value or current step temperature. (If PV indication is selected during PV/SV indication selection, input value is indicated. If SV indication is selected during PV/SV indication selection, "4.63" is indicated.)

- **When control output OFF function is working;**

The MEMO/STEP display is turned off, and the PV/SV display indicates "OFF".

(2) Input each setting value.

Input each setting value, referring to "6. Operation".

(3) Turn the load circuit power ON.

The controller starts as follows depending on the setting.

- **Fixed value control**

Control starts so as to keep the controlled object at the SV.

- **Program control**

- Program control run**

- To perform program control run, press the ① key. At this time the program control starts with PV start.

- PV start: When the program control starts, SV and step time are advanced to the PV, then the program control is performed.

- Program control stop**

- To stop program control, press the ① key for approx. 1 second. The program control stops, and the controller reverts to the program control standby mode.

- Action after power failure is restored**

- If power failure occurs during the program control run, the control resumes from the point at which power failure occurred.

- If power failure occurs during program control standby mode, the control resumes from the program control standby mode.

- Progressing time error after power failure is restored: Within ± 1 minute regardless of step time unit



- **Converter**

- Each input value (thermocouple, RTD, DC current, DC voltage) is converted to 4 to 20mA DC and outputted.

- Input/output response is approx. 1 seconds.

- When using an alarm action, select Process alarm during A1, A2 action selection.

7.2 MV (Control output manipulated variable) indication

To indicate MV, hold down the  key for approx. 3 seconds in the PV/SV display mode. Keep pressing the  key until MV appears, though setting item SV1 (step 1 step SV) appears during the process.

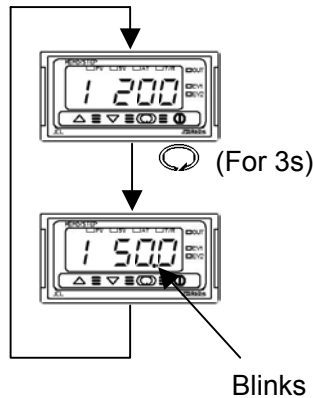

PV/SV display mode

Hold down the  key for approx. 3 seconds.

Keep pressing the  key until MV appears, though setting item SV1 (step 1 step SV) appears during the process.

MV (Control output manipulated variable) indication

The MEMO/STEP display indicates a memory number during fixed value control and a step number during program control.

The PV/SV display indicates MV.

While MV is being indicated, the 1st decimal point from the right blinks in a 0.5 second cycle.

To release MV indication function, press the  key again or turn the power of the JCL-33A off and on again.

7.3 Control output OFF function

This is a function to pause the control action or to turn the control output of the unused instrument of the plural units OFF even if the power to the instrument is supplied.

To turn the control output OFF, press the  key for approx. 1 second in the PV/SV display.

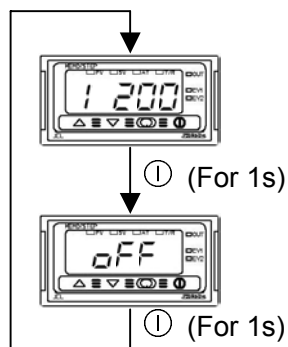

PV/SV display mode

Press the  key for approx. 1 second.

Control output OFF

The MEMO/STEP display is turned off and the PV/SV display indicates . Once the control output OFF function is enabled, the function cannot be released even if the power to the instrument is turned OFF and ON again.



To cancel the function, press the  key again for approx. 1 second.

7.4 Auto-tuning (AT) Perform/Cancel

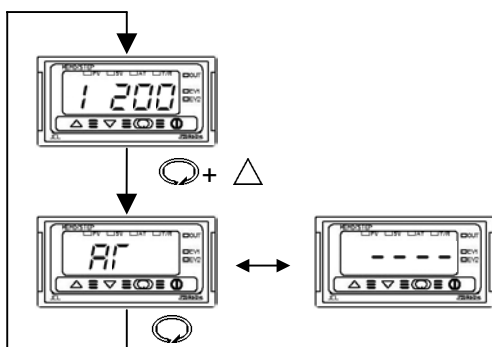



Auto-tuning Perform/Cancel can be selected during AT selection in the Sub setting mode.



PV/SV display mode

Press the  key while holding down the  key.

AT selection in the Sub setting mode

Select Auto-tuning Perform () with the  key and Auto-tuning Cancel () with the  key, then press the  key. The AT indicator blinks while performing auto-tuning.

If Auto-tuning is cancelled during the process, P, I, D, ARW values return to the former values.

If PID auto-tuning does not finish in 4 hours after starting, PID auto-tuning is cancelled automatically.

8. Operation flowchart

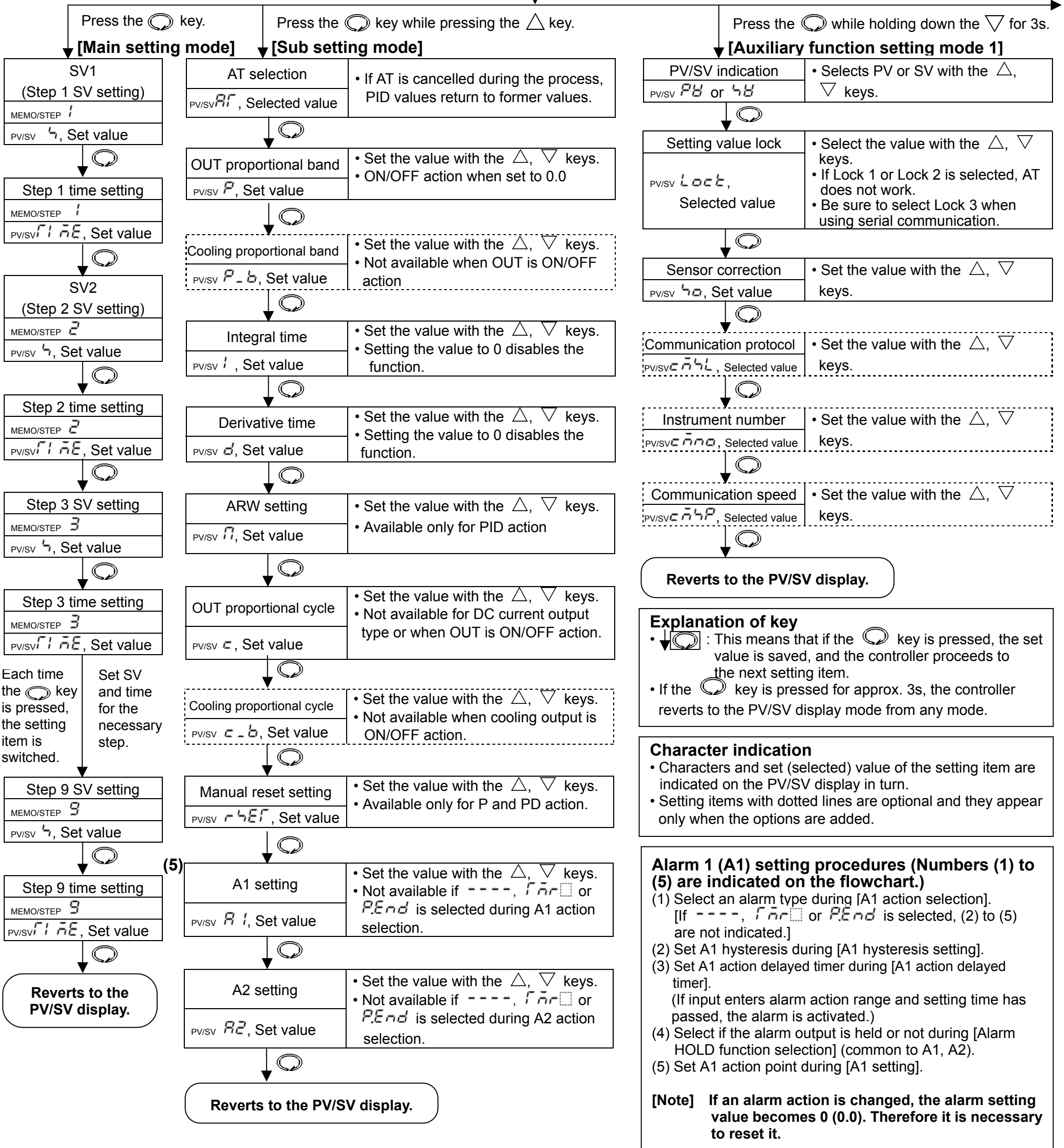
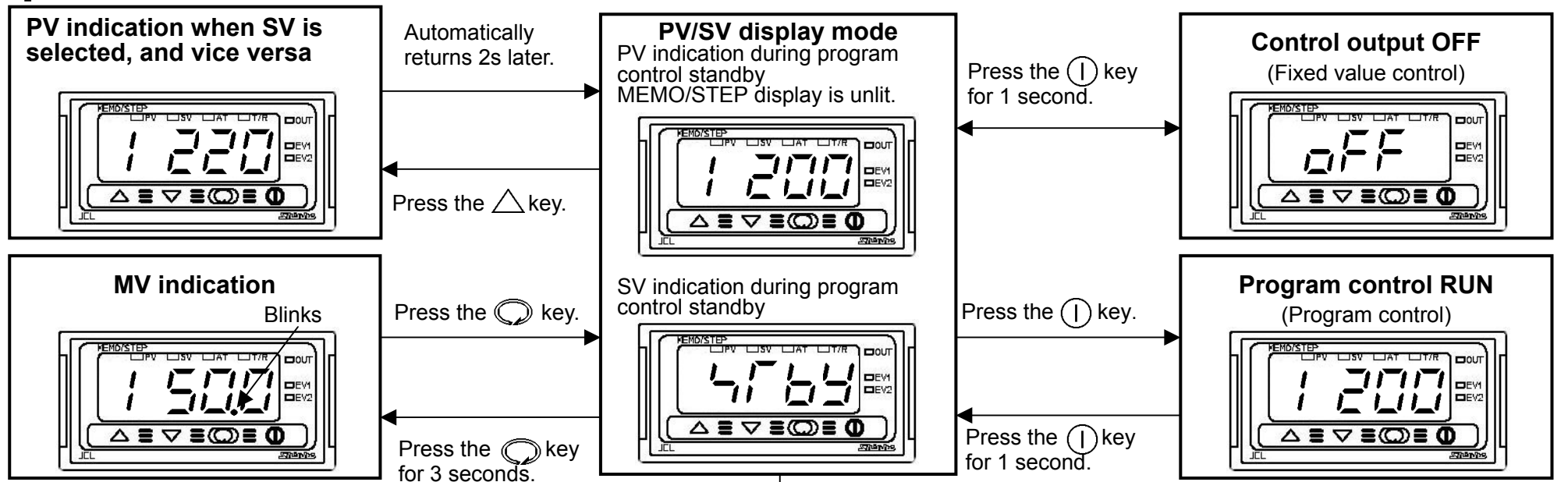

Input type (Character indication) and range			
$t_{\square\square\square}$: K	-200 to 1370 °C	$t_{\square\square\square}$: K	-320 to 2500 °F
$t_{\square\square}$: °C	-199.9 to 400.0 °C	$t_{\square\square}$: °F	-199.9 to 750.0 °F
$J_{\square\square\square}$: J	-200 to 1000 °C	$J_{\square\square\square}$: J	-320 to 1800 °F
$r_{\square\square\square}$: R	0 to 1760 °C	$r_{\square\square\square}$: R	0 to 3200 °F
$s_{\square\square\square}$: S	0 to 1760 °C	$s_{\square\square\square}$: S	0 to 3200 °F
$b_{\square\square\square}$: B	0 to 1820 °C	$b_{\square\square\square}$: B	0 to 3300 °F
$e_{\square\square\square}$: E	-200 to 800 °C	$e_{\square\square\square}$: E	-320 to 1500 °F
$f_{\square\square}$: T	-199.9 to 400.0 °C	$f_{\square\square}$: T	-199.9 to 750.0 °F
$n_{\square\square}$: N	-200 to 1300 °C	$n_{\square\square}$: N	-320 to 2300 °F
$PL2C$: PL-II	0 to 1390 °C	$PL2F$: PL-II	0 to 2500 °F
$c_{\square\square}$: C(W/Re5-26)	0 to 2315 °C	$c_{\square\square}$: C(W/Re5-26)	0 to 4200 °F
Pt_{\square} : Pt100	-199.9 to 850.0 °C	Pt_{\square} : Pt100	-199.9 to 999.9 °F
JPt_{\square} : JPt100	-199.9 to 500.0 °C	JPt_{\square} : JPt100	-199.9 to 900.0 °F
Pt_{\square} : Pt100	-200 to 850 °C	Pt_{\square} : Pt100	-300 to 1500 °F
JPt_{\square} : JPt100	-200 to 500 °C	JPt_{\square} : JPt100	-300 to 900 °F
$420A$: 4 to 20mA DC	-1999 to 9999	$010B$: 0 to 1V DC	-1999 to 9999
$020A$: 0 to 20mA DC	-1999 to 9999	$050B$: 0 to 5V DC	-1999 to 9999
		$105B$: 1 to 5V DC	-1999 to 9999
		$010B$: 0 to 10V DC	-1999 to 9999

Alarm action types	
$H_{\square\square}$	(High limit alarm): The alarm action is \pm deviation setting to the SV. The alarm is activated if the input value reaches the high limit setting value.
$L_{\square\square}$	(Low limit alarm): The alarm action is \pm deviation setting to the SV. The alarm is activated if the input value goes under the low limit setting value.
$HL_{\square\square}$	(High/Low limits alarm): Combines High limit and Low limit alarm actions. When input value reaches high limit setting value or goes under the low limit setting value, the alarm is activated.
$Al d_{\square}$	(High/Low limit range alarm): When input value is between the high limit setting value and low limit setting value, the alarm is activated.
$RA_{\square\square}$	(Process high alarm), $rRA_{\square\square}$ (Process low alarm): Within the scale range of the controller, alarm action points can be set at random and if the input reaches the randomly set action point, the alarm is activated.
$H_{\square\square}$	(High limit alarm with standby), $L_{\square\square}$ (Low limit alarm with standby)
$HL_{\square\square}$	(High/Low limits alarm with standby) When the power to the controller is turned on, even if the input enters the alarm action range, the alarm is not activated. (If the controller is allowed to keep running, once the input exceeds the alarm action point, the standby function will be released.)
rAr_{\square}	(Timer function): If external signal enters, timer counting starts, and the action selected during Delay action type selection is outputted after the set delay time has passed.
$PEnd$	(Pattern end output): When the program ends normally, pattern end output is turned on. The output is maintained until it is released with the \odot key.

Press ∇ key for 3s while holding down the \triangle key.

[Auxiliary function setting mode 2]

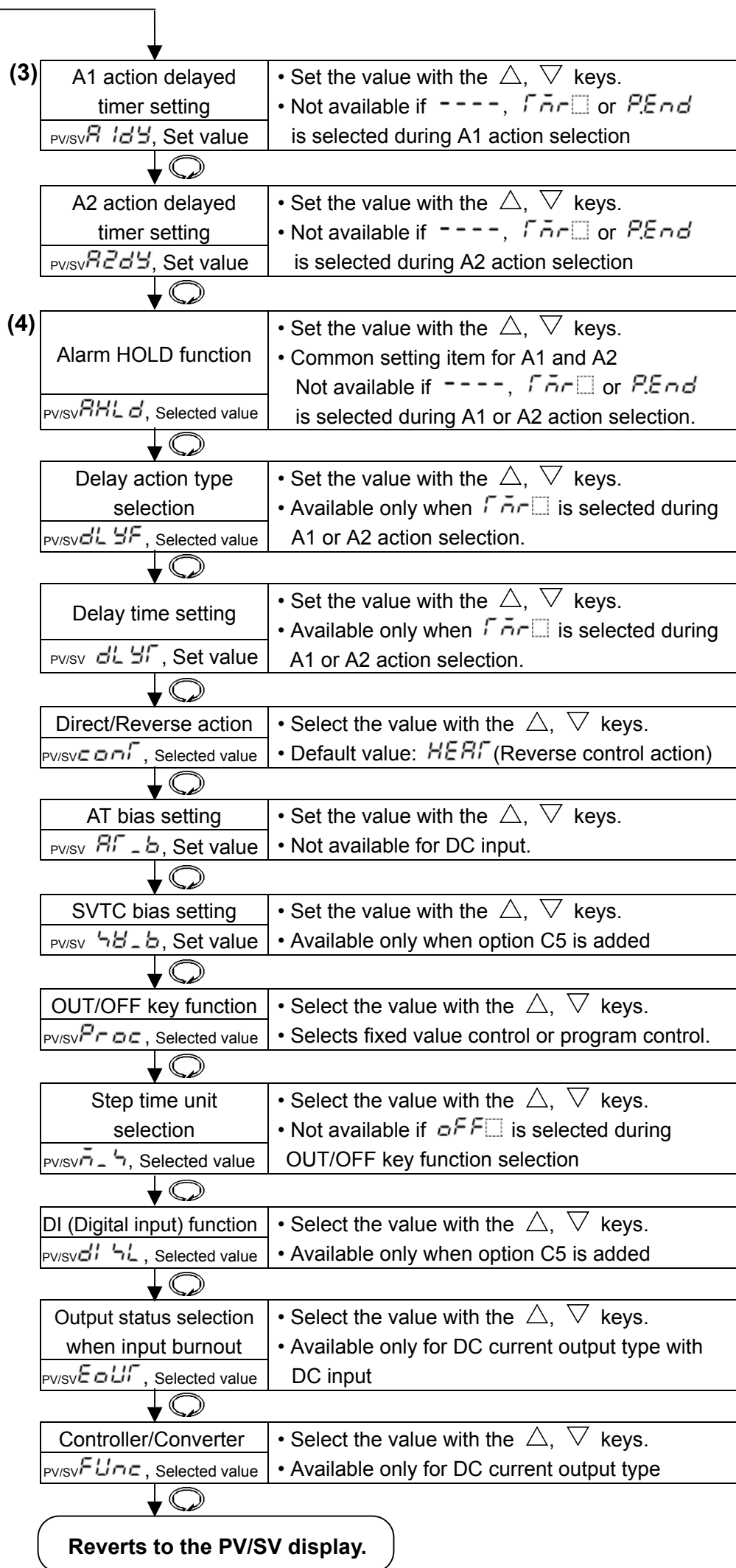
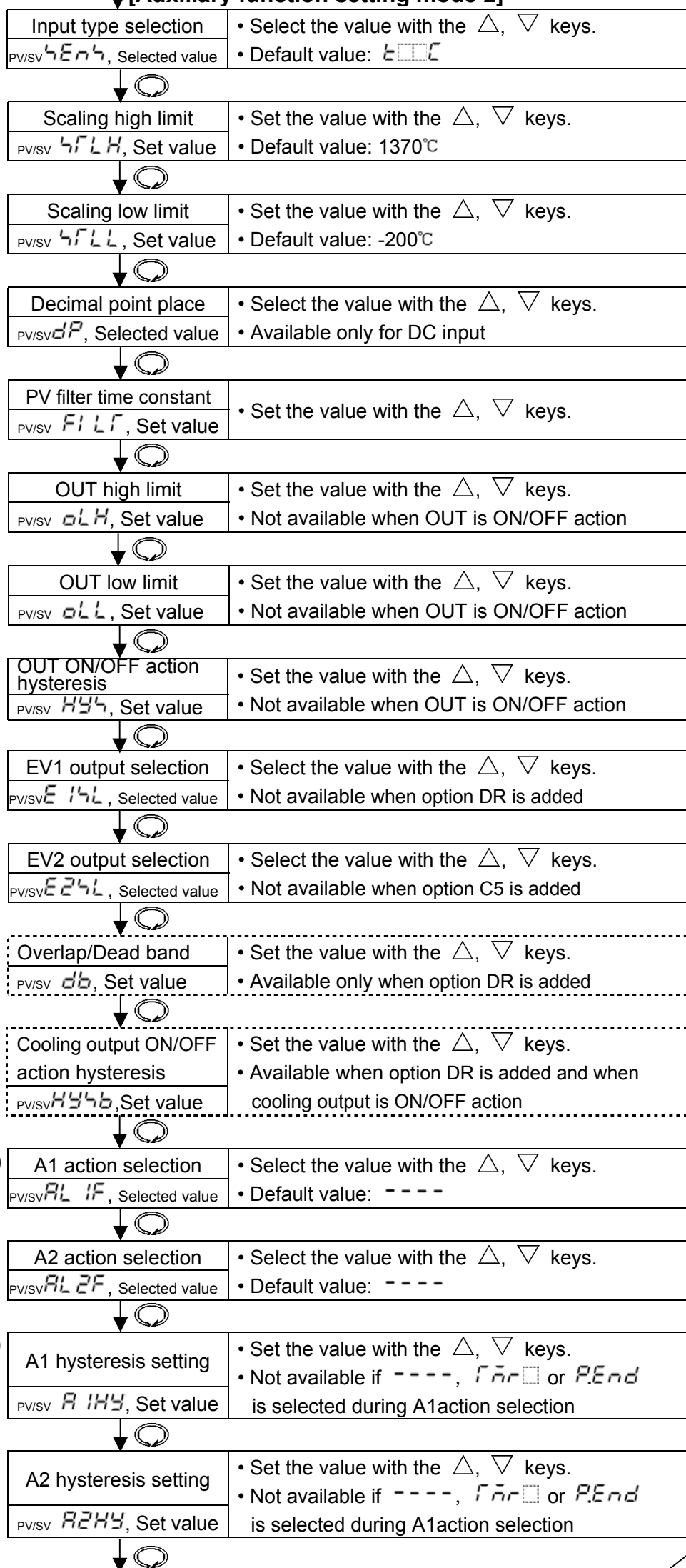

9. PID auto-tuning

In order to set each value of P, I, D and ARW automatically, fluctuation is applied to the controlled object to get an optimal value.

⚠ Notice

- Perform auto-tuning during trial run.
- During auto-tuning, none of the setting items can be set.
- If auto-tuning starts during program control run, auto-tuning performs with SV at which auto-tuning starts. The step time does not progress until auto-tuning ends.
- If power failure occurs during auto-tuning, auto-tuning stops.

(A) When the difference between the setting value and processing temperature is large as the temperature rises

When AT bias is set to 20°C (°F), fluctuation is applied at the temperature 20°C lower than the setting value.

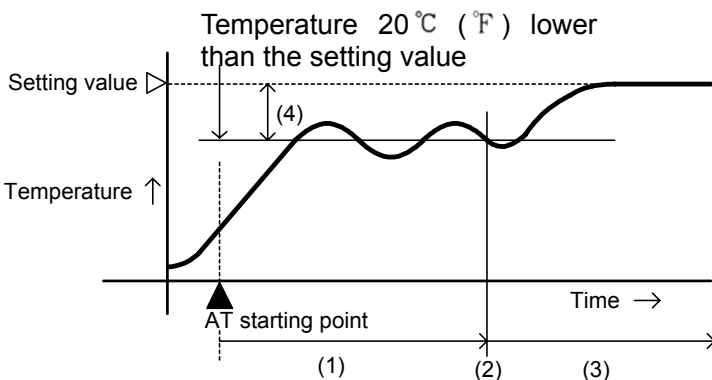

- (1) Calculating PID constant
- (2) PID constant calculated
- (3) Controlled by the PID constant set by auto-tuning.
- (4) AT bias value

(Fig. 9-1)

(B) When the control is stable

Fluctuation is applied at the setting value.

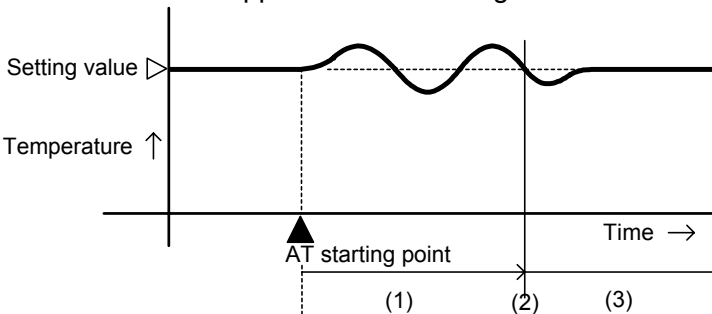

- (1) Calculating PID constant
- (2) PID constant calculated
- (3) Controlled by the PID constant set by auto-tuning.

(Fig. 9-2)

(C) When the difference between the setting value and processing temperature is large as the temperature falls

When AT bias is set to 20°C (°F), fluctuation is applied at the temperature 20°C (°F) higher than the setting value.

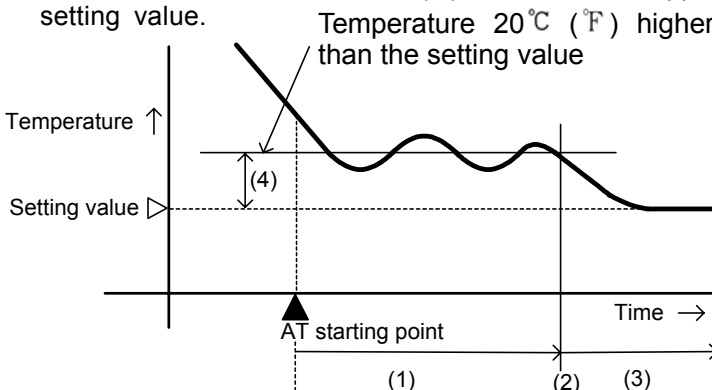

- (1) Calculating PID constant
- (2) PID constant calculated
- (3) Controlled by the PID constant set by auto-tuning.
- (4) AT bias value

(Fig. 9-3)

For DC input, fluctuation is applied at the setting value for conditions of (A), (B) and (C).

10. Action explanation

10.1 OUT action

	Heating (Reverse) action	Cooling (Direct) action
Control action		
Relay contact output	<p>Cycle action is performed according to deviation</p>	<p>Cycle action is performed according to deviation</p>
Non-contact voltage output	<p>Cycle action is performed according to deviation</p>	<p>Cycle action is performed according to deviation</p>
DC current output	<p>Changes continuously according to deviation</p>	<p>Changes continuously according to deviation</p>
Indication (OUT) Green	<p>Lit Unlit</p>	<p>Unlit Lit</p>

part: Acts ON or OFF.

10.2 OUT ON/OFF action

	Heating (Reverse) action	Cooling (Direct) action
Control action		
Relay contact output		
Non-contact voltage output		
DC current output		
Indication (OUT) Green	<p>Lit Unlit</p>	<p>Unlit Lit</p>

part: Acts ON or OFF.

10.3 A1, A2 action

: Standby functions in this section.

EV1, EV2 indicators light when terminals between 8 and 9 or between 11 and 12 are connected, and go out when between them are disconnected.

10.4 Heating/Cooling control action (When option DR is added)

Control action			
Relay contact output (OUT)			
Non-contact voltage output (OUT)			
DC current output (OUT)			
Relay contact output (EV1)			
Indication (OUT) Green			
Indication (EV1) Yellow			

: Acts ON (lit) or OFF (unlit).

————— : Represents Heating control action.

- - - - - : Represents Cooling control action.

10.5 Heating/Cooling control action (When setting dead band) (When option DR is added)

Control action			
Relay contact output (OUT)	<p>Cycle action is performed according to deviation.</p>		
Non-contact voltage output (OUT)	<p>Cycle action is performed according to deviation.</p>		
DC current output (OUT)	<p>Changes continuously according to deviation.</p>		
Relay contact output (EV1)	<p>Cycle action is performed according to deviation.</p>		
Indication (OUT) Green			
Indication (EV1) Yellow			

: Acts ON (lit) or OFF (unlit).
 ————— : Represents Heating control action.
 - - - - - : Represents Cooling control action.

10.6 Heating/Cooling control action (When setting overlap band) (When option DR is added)

Control action			
Relay contact output (OUT)	<p>Cycle action is performed according to deviation.</p>		
Non-contact voltage output (OUT)	<p>Cycle action is performed according to deviation.</p>		
DC current output (OUT)	<p>Changes continuously according to deviation.</p>		
Relay contact output (EV1)	<p>Cycle action is performed according to deviation.</p>		
Indication (OUT) Green			
Indication (EV1) Yellow			

: Acts ON (lit) or OFF (unlit).
 ————— : Represents Heating control action.
 - - - - - : Represents Cooling control action.

10.7 Timer action

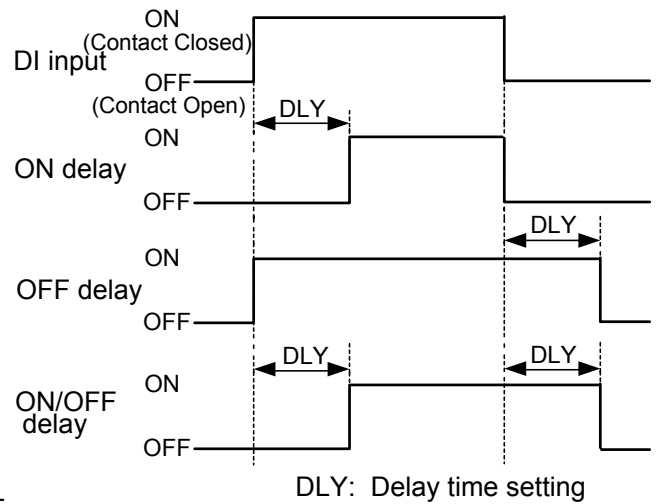

11. Specifications

11.1 Standard specifications

Mounting method : Flush
Setting method : Input system using membrane sheet key
Display PV/SV display: Red LED 4 digits, character size 8.7 x 5 mm (H x W)
MEMO/STEP display: Green LED 1 digit, character size 8.7 x 5 mm (H x W)

Accuracy (Setting and Indication):

Thermocouple : Within $\pm 0.2\%$ of each input span ± 1 digit, or within $\pm 2^\circ\text{C}$ (4°F), whichever is greater
However R, S input, 0 to 200°C (400°F): Within $\pm 6^\circ\text{C}$ (12°F)
B input, 0 to 300°C (600°F): Accuracy is not guaranteed
K, J, E, T, N input, less than 0°C (32°F): Within $\pm 0.4\%$ of input span ± 1 digit or within $\pm 4^\circ\text{C}$ (8°F), whichever is greater

RTD : Within $\pm 0.1\%$ of each input span ± 1 digit, or within $\pm 1^\circ\text{C}$ (2°F), whichever is greater

DC current : Within $\pm 0.2\%$ of each input span ± 1 digit

DC voltage : Within $\pm 0.2\%$ of each input span ± 1 digit

Input sampling period : 0.25 seconds

Input Thermocouple : K, J, R, S, B, E, T, N, PL-II, C (W/Re5-26) External resistance, 100Ω or less
(However, B input: External resistance, 40Ω or less)

RTD : Pt100, JPt100, 3-wire system
Allowable input lead wire resistance (10Ω or less per wire)

DC current : 0 to 20mA DC, 4 to 20mA DC
Input impedance: Externally install 50Ω shunt resistor.
Allowable input current (50mA DC or less)

DC voltage : 0 to 1V DC Input impedance ($1\text{M}\Omega$ or greater)
Allowable input voltage (5V DC or less)
Allowable signal source resistance ($2\text{k}\Omega$ or less)
: 0 to 5V DC, 1 to 5V DC, 0 to 10V DC Input impedance ($100\text{k}\Omega$ or greater)
Allowable input voltage (15V DC or less)
Allowable signal source resistance (100Ω or less)

Control output (OUT)

Relay contact : 1a, Control capacity 3A 250V AC (resistive load)
1A 250V AC (inductive load $\cos\phi=0.4$)
Electrical life, 100,000 times

Non-contact voltage (For SSR drive): Max. 40mA 12°V DC (short-circuit protected)

DC current : 4 to 20mA DC, Load resistance, Max. 550Ω

Event output 1 (EV1), Event output 2 (EV2)

One type can be selected from 10 types of alarm action (including No alarm action), Timer function and Pattern end output.

Alarm setting range : See (Table 6.2-1) on page 17.

Action : ON/OFF action

Hysteresis TC, RTD input : 0.1 to 100.0°C ($^\circ\text{F}$)
DC current, voltage input: 1 to 1000 (The placement of the decimal point follows the selection)

A1, A2 delayed timer function: 0 to 9999 seconds

Alarm output HOLD function : Once the alarm is activated, the alarm output is maintained until the power supply to the instrument is turned off.

Timer function : 0 to 9999 seconds

Pattern end output : Pattern end output is turned on when the program ends normally.

EV1 output : Relay contact 1a
Control capacity, 3A 250V AC (resistive load)
1A 250V AC (inductive load $\cos\phi=0.4$)
Electrical life, 100,000 times

EV2 output : Open collector, Control capacity, 0.1A (maximum) 24V DC

Control action

PID action (with auto-tuning function)

PI action: When derivative time is set to 0

PD action (with manual reset function): When integral time is set to 0

P action (with manual reset function): When derivative and integral times are set to 0.

ON/OFF action: When proportional band is set to 0

OUT proportional band: 0.0 to 110.0% (ON/OFF action when set to 0.0)

Integral time : 0 to 1000s (OFF when set to 0)

Derivative time : 0 to 300s (OFF when set to 0)

OUT proportional cycle: 1 to 120s (Not available for DC current output type)

ARW : 0 to 100%

Manual reset : \pm Proportional band converted value

OUT ON/OFF action hysteresis: 0.1 to 100.0°C ($^\circ\text{F}$), or 1 to 1000

OUT output limit : 0 to 100% (DC current output type: -5 to 105%)

DI (Digital input)

DI (Digital input) has 3 functions.

- SV1/SV2 external selection function

SV1 or SV2 can be switched by external contact.

However, this function is not available if Program control function is selected during OUT/OFF key function selection.

DI terminals between 10 and 12 Open: SV1

DI terminals between 10 and 12 Closed: SV2

- OUT/OFF (RUN/STOP) external selection function

Control output OUT/OFF (Fixed value control) or Program control RUN/STOP can be switched.

[Fixed value control]

DI terminals between 10 and 12 Open: OUT (Control allowed)

DI terminals between 10 and 12 Closed: OFF (Control prohibited, control output OFF, $\square FF \square$ is indicated.)

[Program control]

Program control RUN/STOP can be switched by external contact pulse input (ON time, approx. 30ms).

If pulse input enters during program control standby, program control starts.

If pulse input enters during program control run, program control stops and the controller reverts to the program control standby mode.

If pulse input enters while pattern end output is turned ON after program control ended, pattern end output is turned off. Circuit current when closed: 6mA

- Timer function

Timer counting starts by the external contact, and after the set delay time has passed, the selected event output is turned on.

Program control function

If program control function is selected during OUT/OFF key function selection, 1 pattern 9 steps program control can be performed.

To start program control, press the $\text{\textcircled{1}}$ key during program control standby.

(To stop the program control, press the $\text{\textcircled{1}}$ key for approx. 1 second again.)

Progressing time error: Within ± 1 minute

Pattern end output: Pattern end output can be selected by keypad.

Converter function

If Converter function is selected during Controller/Converter function selection, the following control parameters are automatically set, and the controller can be used as a converter. (However, available only for DC current output type)

Input/output response is approx. 1 second.

SV1 (main setting) : Scaling low limit value, Integral time: 0, Derivative time: 0,

OUT proportional band: 100.0%, Manual reset: 0.0, A1 setting: 0, A2 setting: 0,

Direct/Reverse action : Direct action

Attached functions

[Setting value lock] Locks setting values to prevent setting errors.

[Sensor correction] The PV is corrected when the temperatures in the controlled location differs from those of the sensor location.

[PV filter] Reduces the effect of noise by putting first order lag filter in the PV.

[Power failure countermeasure] The setting data is backed up in the non-volatile IC memory.

[Self-diagnosis]

The CPU is monitored by a watchdog timer, and when any abnormal status is found on the CPU, the controller is switched to warm-up status.

[Automatic cold junction temperature compensation] (Only thermocouple input type)

This detects the temperature at the connecting terminal between the thermocouple and the instrument, and always maintains it at the same status as when the reference junction is located at 0°C (32°F).

[Burnout]

When the thermocouple or RTD input is burnt out, OUT and EV1 (option DR) are turned off [for DC current output type, OUT (Heating side) low limit value] and PV/SV display blinks “ $\square \square \square \square$ ”.

[Input burnout indication]

Indication	Contents	OUT	EV1 (Option DR)
" - - - - " Blinks.	Overscale Measured value has exceeded Indication range high limit value.	If measured value exceeds Control range high limit value: OFF(4mA) or OUT low limit value	OFF (*)
" - - - - " Blinks.	Underscale Measured value has dropped below Indication range low limit value.	If measured value drops below Control range low limit value: OFF (4mA) or OUT low limit value (*)	OFF

(*) For DC input and DC current output type, if “ $\square \square \square \square$ ” (Output ON) is selected during Output status selection when input burnout, ON (20mA) or OUT high limit value is indicated.

Thermocouple and RTD input

Input	Input range	Indication range	Control range
K, T	-199.9 to 400.0°C	-199.9 to 450.0°C	-205.0 to 450.0°C
	-199.9 to 750.0°F	-199.9 to 850.0°F	-209.0 to 850.0°F
Pt100	-199.9 to 850.0°C	-199.9 to 900.0°C	-210.0 to 900.0°C
	-200 to 850°C	-210 to 900°C	-210 to 900°C
	-199.9 to 999.9°F	-199.9 to 999.9°F	-211.0 to 1099.9°F
	-300 to 1500°F	-318 to 1600°F	-318 to 1600°F
JPt100	-199.9 to 500.0°C	-199.9 to 550.0°C	-206.0 to 550.0°C
	-200 to 500°C	-207 to 550°C	-207 to 550°C
	-199.9 to 900.0°F	-199.9 to 999.9°F	-211.0 to 999.9°F
	-300 to 900°F	-312 to 1000°F	-312 to 1000°F

Indication range and Control range for thermocouple inputs other than the above:
 Input range low limit value -50°C (100°F) to Input range high limit value +50°C (100°F)

DC input

Indication range: Scaling low limit value-Scaling span x 1% to Scaling high limit value- Scaling span x 10%
 However, “ - - - - ” or “ - - - - ” blinks when the range of -1999 to 9999 is exceeded.

Control range: Scaling low limit value-Scaling span x 1% to Scaling high limit value- Scaling span x 10%

DC input burnout: When DC input is burnt out, PV/SV display blinks “ - - - - ” for 4 to 20mA DC and 1 to 5V DC inputs, and “ - - - - ” for 0 to 1V DC input. For 0 to 20mA DC, 0 to 5V DC and 0 to 10V DC inputs, the PV/SV display indicates the corresponding value with which 0mA or 0V is inputted.

[Warm-up indication]

After the power supply to the instrument is turned on, the sensor input character and temperature unit are indicated on the PV/SV display for approx. 3 seconds.

[Temporary PV/SV indication]

If the Increase key is pressed during the PV/SV display mode, the opposite value to the value selected during PV/SV indication selection is indicated while the key is being pressed.

Circuit isolation configuration

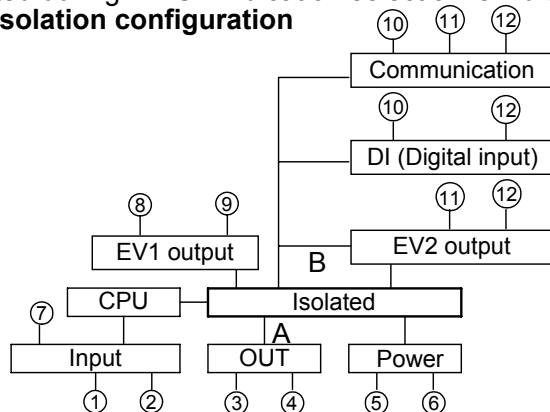

When OUT is non-contact voltage output or DC current output, between A and B is not isolated.

A: Terminals 3, 4

B: Terminals 10, 11, 12

Isolation resistance : 10MΩ or greater at 500V DC

Dielectric strength : 1.5kV AC for 1minute between input terminal and power terminal
 1.5kV AC for 1minute between output terminal and power terminal

Supply voltage : 100 to 240V AC 50/60Hz, 24V AC/DC 50/60Hz

Allowable voltage fluctuation: 100 to 240V AC: 85 to 264V AC, 24V AC/DC: 20 to 28V AC/DC

Power consumption : Approx. 6VA

Ambient temperature : 0 to 50°C (32 to 122°F)

Ambient humidity : 35 to 85%RH (no condensation)

Weight : Approx. 120g

External dimension : 48 x 24 x 98.5mm (W x H x D)

Material : Flame resistant resin (Case)

Color : Light gray (Case)

Accessories included : Instruction manual 1 copy, Mounting frame 1 piece
 Terminal cover 1 piece (when option TC is applied)

Accessories sold separately: Shunt resistor 1 piece (50Ω)

11.2 Optional specifications

Heating/Cooling control (Option code: DR)

Cooling proportional band: 0.0 to 10.0 times OUT proportional band (ON/OFF action when set to 0.0)
 Integral time and derivative time are the same as those of OUT action.

Cooling proportional cycle: 1 to 120 seconds

Overlap band/Dead band setting range

TC, RTD input: -100.0 to 100.0°C (°F)

DC input: -1000 to 1000 (The placement of the decimal point follows the selection)

Cooling output ON/OFF action hysteresis setting

TC, RTD input: 0.1 to 100.0°C (°F)

DC input: 1 to 1000 (The placement of the decimal point follows the selection)

Output: Relay contact 1a, Control capacity 3A 250V AC (resistive load),
 1A 250V AC (inductive load cosφ=0.4)

Serial communication (Option code: C5)

The following operations can be carried out from the external computer.

(1) Reading and setting of SV, PID values and each setting value

(2) Reading of the input value and action status (3) Change of the functions

Cable length : Maximum 1000m, Cable resistance, Within 50Ω

Communication line : Based on EIA RS-485

Communication method : Half-duplex communication start-stop synchronous

Communication speed : 2400, 4800, 9600, 19200bps (Can be selected by keypad)

Parity : Even (When Shinko protocol or Modbus ASCII is selected),
No parity (When Modbus RTU is selected)

Stop bit : 1

Communication protocol : Shinko protocol, Modbus RTU, Modbus ASCII (Can be selected by keypad)

Number of connectable units : Maximum 31 units to 1 host computer

Communication error detection: Parity and checksum (LRC), CRC

Color Black (Option code: BK) Front panel frame and case: Black

Terminal cover (Option code: TC) Electrical shock protection terminal cover

12. Troubleshooting

If any malfunctions occur, refer to the following items after checking the power supply to the controller.

12.1 Indication

Problem	Presumed cause and solution
The PV/SV display is indicating [OFF].	<ul style="list-style-type: none"> Control output OFF function is working. To release the function, press the ① key for approx. 1 second.
The PV/SV display is indicating “4.65”.	<ul style="list-style-type: none"> This is program standby status. If Program control function is selected during OUT/OFF key function selection and if SV is selected during PV/SV indication selection, “4.65” is indicated during program standby. If PV is selected during PV/SV indication selection, the PV is indicated.
The PV/SV display is blinking [- - - -].	<ul style="list-style-type: none"> Thermocouple, RTD or DC voltage (0 to 1V DC) is burnt out. Change each sensor. How to check sensor burnout [Thermocouple] If the input terminal of the instrument is shorted and a value around room temperature is indicated, the instrument is probably normal and sensor may be burnt out. [RTD] If approx. 100Ω of resistance is connected to the input terminals between A-B of the instrument and between B-B is shorted, and a value around 0°C (32°F) is indicated, the instrument is probably normal and sensor may be burnt out. [DC voltage (0 to 1V DC)] If the input terminal of the instrument is shorted and scaling low limit value is indicated, the instrument is probably normal and the signal wire may be burnt out. Is the input terminal of thermocouple, RTD or DC voltage (0 to 1V DC) securely mounted to the instrument input terminal? Connect the sensor terminals to the instrument input terminals securely.
The PV/SV display is blinking [- - - -].	<ul style="list-style-type: none"> Check if input signal source for DC voltage (1 to 5V DC) or DC current (4 to 20mA DC) is normal. How to check each signal wire [DC voltage (1 to 5V DC)] If the input to the input terminals of the instrument is 1V DC and scaling low limit value is indicated, the instrument is probably normal and the signal wire may be disconnected. [DC current (4 to 20mA DC)] If the input to the input terminals of the instrument is 4mA DC and scaling low limit value is indicated, the instrument is probably normal and the signal wire may be disconnected. Is input signal wire for DC voltage (1 to 5V DC) or DC current (4 to 20mA DC) securely connected to the instrument input terminals? Connect the signal lead wire to the instrument input terminals securely. Is polarity of thermocouple or compensating lead wire correct? Do codes (A, B, B) of RTD agree with the instrument terminals? Wire them properly.

The PV/SV display keeps indicating the value which was set during Scaling low limit setting.	<ul style="list-style-type: none"> Check if the input signal source for DC voltage (0 to 5V DC, 0 to 10V DC) and DC current (0 to 20mA DC) is normal. How to check each signal wire [DC voltage (0 to 5V DC, 0 to 10V DC)] If the input to the input terminals of the instrument is 1V DC and the value corresponding to 1V DC is indicated, the instrument is probably normal and the signal wire may be disconnected. [DC current (0 to 20mA DC)] If the input to the input terminals of the instrument is 1mA DC and the value corresponding to 1mA DC is indicated, the instrument is probably normal and the signal wire may be disconnected. Are the input lead wire terminals for DC voltage (0 to 5V DC, 0 to 10V DC) or DC current (0 to 20mA DC) securely mounted to the instrument input terminals? Mount the sensor terminals to the instrument input terminals securely.
The indication of the PV/SV display is abnormal or unstable.	<ul style="list-style-type: none"> Is sensor input or temperature unit (°C or °F) correct? Select the proper sensor input and temperature unit (°C or °F). Sensor correcting value is unsuitable. Set the value suitably. AC leaks into the sensor circuit. Use an ungrounded type sensor. There may be a piece of equipment producing inductive interference or noise near the controller. Keep the equipment producing inductive interference or noise away from the controller.
The PV/SV display is indicating [Err 1].	<ul style="list-style-type: none"> Internal memory is defective. Contact our agency or us.

12.2 Key operation

Problem	Presumed cause and solution
<ul style="list-style-type: none"> Unable to set the SV1, P, I, D, proportional cycle or alarm. The values do not change by the \triangle, ∇ keys. 	<ul style="list-style-type: none"> Setting value lock (Lock 1 or Lock 2) is designated. Release the lock designation. During PID auto-tuning. Cancel the auto-tuning. Has No alarm action, Timer function or Pattern end output been selected during A1, A2 alarm action selection? Select an alarm action after checking the selected value.
SV2 cannot be set.	<ul style="list-style-type: none"> SV1/SV2 external selection function has not been selected during DI (Digital input) function selection. Select SV1/SV2 external selection function after checking the selected value. Not available if option C5 is applied.
The setting indication does not change within the input range even if the ∇ , \triangle keys are pressed, and unable to set the value.	<ul style="list-style-type: none"> Scaling high or low limit value in Auxiliary function setting mode 2 may be set at the point the value does not change. Set the proper value while in Auxiliary function setting mode 2.

12.3 Control

Problem	Presumed cause and solution
Temperature does not rise.	<ul style="list-style-type: none"> Sensor is out of order. Replace the sensor. Sensor or actuator is not securely mounted to the input or output terminals of the instrument. Mount the sensor or actuator to the instrument input or output terminals securely. The wiring of sensor or actuator is incorrect. Connect it properly.
The control output remains ON status.	<ul style="list-style-type: none"> OUT low limit value in Auxiliary function setting mode 2 is set to 100% or greater. Set the value appropriately.
The control output remains OFF status.	<ul style="list-style-type: none"> OUT high limit value in Auxiliary function setting mode 2 is set to 0% or less. Set the value appropriately.
Program control ends soon even if it is performed.	<ul style="list-style-type: none"> Step time has been set to 00:00. Set the step time.
Timer does not work.	<ul style="list-style-type: none"> Is Delay action type or Delay time set properly? Set or select the value properly. Has Timer function been selected during DI (Digital input) function selection? Select Timer function after checking. If option C5 is applied, DI (Digital input) function selection item is not available.

• If you have any inquiries, please consult our agency or the shop where you purchased the unit.

13. Character table

Photocopiable material

[Main setting mode]

Indication	Setting item	Default value	Data
14□□□	SV1 (step 1 step SV) setting	0°C	
171 AE	Step 1 step time setting	00:00	
24□□□	SV2 (step 2 step SV) setting	0°C	
271 AE	Step 2 step time setting	00:00	
34□□□	Step 3 step SV setting	0°C	
371 AE	Step 3 step time setting	00:00	
44□□□	Step 4 step SV setting	0°C	
471 AE	Step 4 step time setting	00:00	
54□□□	Step 5 step SV setting	0°C	
571 AE	Step 5 step time setting	00:00	
64□□□	Step 6 step SV setting	0°C	
671 AE	Step 6 step time setting	00:00	
74□□□	Step 7 step SV setting	0°C	
771 AE	Step 7 step time setting	00:00	
84□□□	Step 8 step SV setting	0°C	
871 AE	Step 8 step time setting	00:00	
94□□□	Step 9 step SV setting	0°C	
971 AE	Step 9 step time setting	00:00	

[Sub setting mode]

Indication	Setting item	Default value	Data
AT□□□	AT (Auto-tuning) selection	Cancel	
P□□□	OUT (Heating side) proportional band	2.5%	
P_b□□	Cooling proportional band	1.0 times	
I□□□	Integral time setting	200 seconds	
d□□□	Derivative time setting	50 seconds	
AR□□	ARW setting	50%	
c□□□	OUT (Heating side) proportional cycle	Relay contact: 30s Non-contact: 3s DC current: Unavailable	
c_b□□	Cooling proportional cycle setting	30 seconds	
r4EF	Manual reset setting	0.0°C	
A1□□	A1 setting	0°C	
A2□□	A2 setting	0°C	

[Auxiliary function setting mode 1]

Indication	Setting item	Default value	Data
PH□□	PV/SV indication selection	PV indication	
Loct	Setting value lock selection	Unlock	
40□□	Sensor correction setting	0.0°C	
cā4L	Communication protocol selection	Shinko protocol	
cā00	Instrument number setting	0	
cā4P	Communication speed selection	9600bps	

[Auxiliary function setting mode 2]

Indication	Setting item	Default value	Data
<input type="checkbox"/> 4En4	Input type selection	K: -200 to 1370°C	
<input type="checkbox"/> 4FLH	Scaling high limit value setting	1370°C	
<input type="checkbox"/> 4FLl	Scaling low limit value setting	-200°C	
<input type="checkbox"/> dP□□	Decimal point place selection	No decimal point	
<input type="checkbox"/> FILT	PV filter time constant setting	0.0 seconds	
<input type="checkbox"/> oLH□	OUT high limit setting	100%	
<input type="checkbox"/> oLL□	OUT low limit setting	0%	
<input type="checkbox"/> H44□	OUT ON/OFF action hysteresis setting	1.0°C	
<input type="checkbox"/> E14L	EV1 output selection	A1 output	
<input type="checkbox"/> E24L	EV2 output selection	A2 output	
<input type="checkbox"/> db□□	Overlap band/Dead band setting	0.0°C	
<input type="checkbox"/> H44b	Cooling ON/OFF action hysteresis setting	1.0°C	
<input type="checkbox"/> AL1F	Alarm 1 (A1) action selection	No alarm action	
<input type="checkbox"/> AL2F	Alarm 2 (A2) action selection	No alarm action	
<input type="checkbox"/> A1H4	Alarm 1 (A1) hysteresis setting	1.0°C	
<input type="checkbox"/> A2H4	Alarm 2 (A2) hysteresis setting	1.0°C	
<input type="checkbox"/> A1d4	A1 action delayed timer setting	0 seconds	
<input type="checkbox"/> A2d4	A2 action delayed timer setting	0 seconds	
<input type="checkbox"/> AHLd	Alarm HOLD function selection	Alarm HOLD [Not used]	
<input type="checkbox"/> dLYF	Delay action type selection	ON delay	
<input type="checkbox"/> dLYT	Delay time setting	0 seconds	
<input type="checkbox"/> conT	Direct (Cooling)/Reverse (Heating) action	Reverse (Heating)	
<input type="checkbox"/> AT_b	AT bias setting	20°C	
<input type="checkbox"/> 4B_b	SVTC bias setting	0°C	
<input type="checkbox"/> Proc	OUT/OFF key function selection	Control output OUT/OFF	
<input type="checkbox"/> n_4□	Step time unit selection	Hour:Minute	
<input type="checkbox"/> di_4L	DI (Digital input) function selection	SV1/SV2 external selection	
<input type="checkbox"/> EoUT	Output status selection when input burnout	Output OFF	
<input type="checkbox"/> Func	Controller/Converter function selection	Controller function	

**SHINKO TECHNOS CO.,LTD.
OVERSEAS DIVISION**

Reg. Office : 1-2-48, Ina, Minoo, Osaka, Japan
 Mail Address : P.O.Box 17, Minoo, Osaka, Japan
 URL : <http://www.shinko-technos.co.jp>
 E-mail : overseas@shinko-technos.co.jp

Tel : 81-72-721-2781
 Fax: 81-72-724-1760